



Spec Guide

ZipTwo | Square 3535 | Low Glare | 707



Direct lighting for open office and ambient applications.

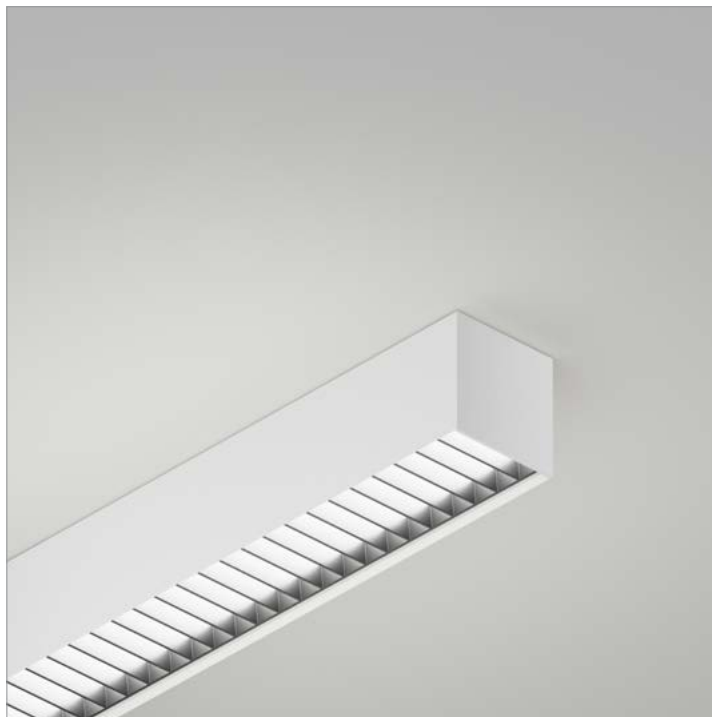

Square 3535, Low Glare, Graphite Baffle, White Finish

Benefits & Features

Low Profile Design

Square profile. 1.38" (35mm) x 1.42" (36mm).

Superior Light Quality & Performance

Output up to 905 lm/ft (HO), 92 lm/W (HO). 80 or 90 CRI. UGR ranging from 3-22.

Versatile Mounting, Easy Installation

Magnet with tape-on metal strip or low profile clip allow for mounting to almost any surface or T-Bar ceiling.

Low Glare & Optical Control

Low glare louvers and optics with nano structure technology now available to give designers the power to create and design spaces without sacrificing visual comfort.



Square 3535, Low Glare, Graphite Baffle, Black Finish

Build Your Specification

707-Z2	SL				0
--------	----	--	--	--	---

System & Rail Type	System Type	System Length	Rail Length	Mounting	Arm/Cable Length
707-Z2 ZipTwo	SL Standard Linear	Specify overall system length in ft/in or M/mm. <i>Corner and Shapes Available See Guide for details.</i>	24 24" (610mm) 36 36" (914mm) 48 48" (1219mm) 60 60" (1524mm) 72 72" (1829mm) 96 96" (2438mm) 108 108" (2743mm) 120 120" (3048mm) 132 132" (3352mm) 144 144" (3658mm) ZZ Other rail length or layout (please specify) <i>See Rail Length Chart for more details.</i>	C Clip CM Clip with Micro J-Box ¹ T Magnet with Tape-On Metal Strip T1 9/16" T-Bar Clip, low profile T2 15/16" T-Bar Clip, low profile T3 15/16" T-Bar Clip, medium profile T4 15/16" T-Bar Clip, concealed T5 9/16" T-Bar Clip, medium profile T6 Slotted T-Bar Clip T7 Dimensional T-Bar Clip SC Strut Channel Clip ¹ DM Armstrong DynaMax ZZ Other (please specify) Wood Ceiling G1 Grille Tegular Vertical Slats 9/16" G2 Grille Tegular Vertical Slats 15/16" G3 Grille Tegular Horizontal Slats G4 Grille 1-3/8" Slat G5 Grille 2-1/4" Slat Height G6 Grille 3-1/4" Slat Height Armstrong Ceilings Add an 'A' to the end of the mounting spec code Examples: G1A, G6A, T1A	0 None 48 48" cable (1219mm) 96 96" cable (2438mm) ZZ Other (please specify)

»				»
---	--	--	--	---

Power Location	Power Type	Voltage	Emergency Power
Remote Power RP10 10' (3.048m) Wire Harness RP25 25' (7.62m) Wire Harness RP50 50' (15.24m) Wire Harness RP75 75' (22.86m) Wire Harness RP100 100' (30.48m) Wire Harness	Flexible 1 to 1 Power AE 0-10v, 1.0% Dimming AT 0-10v, 0.1% Dimming AD DALI, 0.1% Dimming AX DMX, 100-0% Dimming AH Hi-lume 1% EcoSystem, Soft On / Fade to Black Technology, LDE AH2 ELV 1% 2-wire (Forward and Reverse Phase) ⁵ Optimized Power Add 'O' to power type example: AEO, ATO...etc. ² VodeNODE Add 'N' to power type for Flexible 1 to 1 Power Add 'ON' to power type for Optimized Power example: AEN, ATN, AEON, ADON...etc. ³ ZZ Other (please specify) <i>See Power Guide for driver features & limitations.</i>	1 120v 2 120v-277v X Not Yet Specified	0 No Emergency Power ZZ Emergency Power (specify requirements)

»	Z			
---	---	--	--	--

LED Type	Lumen Output	Color Temperature	Optics	Sensors
Z Zipper Board	LO Low Output SO Standard Output HO High Output ZZ Other (please specify) <i>See IES Files page for details.</i> <i>See Power Guide for driver features & limitations.</i>	80+ CRI 27 2700K 30 3000K 35 3500K 40 4000K 90+ CRI 279 2700K 309 3000K 359 3500K 409 4000K ZZ Tunable White Available See Guide for details.	Low Glare BAGB Asymmetric Wallwash Graphite Baffle BAWB Asymmetric Wallwash White Baffle B1GB 25° Symmetric Graphite Baffle B1WB 25° Symmetric White Baffle B2GB 60° Symmetric Graphite Baffle B2WB 60° Symmetric White Baffle B3GB 120° Diffuse Graphite Baffle B3WB 120° Diffuse White Baffle B4GB Bisymmetric Graphite Baffle B4WB Bisymmetric White Baffle	0 None ZZ Other (please specify) ⁴

»	
---	--

Finish	Options
WH White	0 None
BL Black	9 9' 18/3 Cord and Plug

NOTES & LIMITATIONS

¹ Custom modification available for Chicago Plenum. Contact factory.
² Optimized Power is not available with Hi-lume 1% EcoSystem (AHO) Power Type.
³ VodeNODE enclosure is not available with ELV 1% 2-wire (AH2) Power Type.
⁴ Sensors are available please contact Vode for more information.
⁵ Lengths of 24" and shorter are not supported due to driver limitations. Daisy chaining multiple fixtures to achieve minimum load is permitted but may introduce installation complexity—consult factory for layout guidance.

Listed to UL standards for damp location by a Nationally Recognized Testing Laboratory (NRTL) recognized by OSHA. Certain limitations exist for each Certification. Contact factory for verification.

Standard 5 Year Limited Warranty. See details [here](#). Contact factory for options on Limited Warranties up to 20 years.



Declare Label

All Vode Lighting linear light fixtures proudly carry the Red List Approved designation.

See [International Living Future Institute](https://www.living-future.org/declare) website for details.



Declare.

Vode Adaptive Architectural Lighting Systems

Vode Lighting LLC

Final Assembly: Sonoma, California, US
Life Expectancy: 10+ Year(s)
End of Life Options: Recyclable (100%)

Ingredients:

Anodized Aluminum (6063-T5 Alloy); Steel; Small Electrical Component (RoHS)¹; Copper; **Fluorinated Ethylene Propylene (masterbatch)**²; Polymethyl methacrylate (PMMA); Stainless Steel; Polyoxymethylene Copolymer (POM); Styrene-butadiene polymer, hydrogenated; Poly(methyl methacrylate/butyl acrylate/styrene) (PMMA/BA/S); Styrene/butadiene copolymer; Distillates; Polypropylene; Calcium carbonate; Polycarbonate; EVA Copolymer; Methyl methacrylate (MMA); Polyphenylene Oxide; Brass; Tin, Organic

¹LBC Temp Exception RL-002 - Small Electrical Components
²LBC Temp Exception RL-023 - Wire Sheathing Subject to NFPA 90A, NFPA 262, UL® 910

Living Building Challenge Criteria: Compliant

I-13 Red List:

<input type="checkbox"/> LBC Red List Free	% Disclosed: 100% at 100ppm
<input checked="" type="checkbox"/> LBC Red List Approved	VOC Content: Not Applicable
<input type="checkbox"/> Declared	

I-10 Interior Performance: Not Applicable
I-14 Responsible Sourcing: Not Applicable

VDE-0001
 EXP. 01 JAN 2025
 Original Issue Date: 2018

MANUFACTURER RESPONSIBLE FOR LABEL ACCURACY
 INTERNATIONAL LIVING FUTURE INSTITUTE™ [living-future.org/declare](https://www.living-future.org/declare)

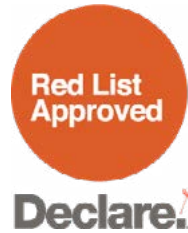

Structure

Rail Lengths	24" (610mm) - 144" (3658mm). Modified lengths available. See Rail Length Chart for more details.
Rail Dimensions	1.38" (35mm) x 1.42" (36mm) x length.
Construction	Extruded and machined 6063 aluminum.
Mounting	Clip, Clip with Micro J-Box, Magnet with Tape-On Metal Strip, T-Bar Clips for most grid/panel construction, Strut Channel Clip.
System Run Length	24" (610mm) minimum. Unlimited maximum.
Operating Temperature	32°F to 104°F (0°C to 40°C).
Humidity	0-95%, non-condensing. Suitable for damp locations.
System Weight	0.25lbs per ft (0.11kg per 305mm). Power supply and housing not included.

Materials

LED Board Construction	Aluminum core PCB, black LCP connectors, RoHS compliant.
Lens	High-impact extruded acrylic glass (PMMA).
Power Cable	Ø3mm, 33/2 AWG, Plenum (CMP) rated semi-rigid PVC or FEP, flame tested UL-910 (<i>PVC free in 2020</i>).
Cable Connectors	Unfilled black nylon, rated UL 94 V-0, halogen free, PVC or FEP overmold, RoHS compliant (<i>PVC free in 2020</i>).
Remote Linear Power Housing (RLP)	20.7" x 2.375" x 2.53", 0.054" formed Galvanized Steel.
Remote Brick Power Housing (RBP)	4.32" x 3.37" x .078" Galvanized Steel mounting plate.

Power and Controls

Power Type	Class 2 (<60V output) constant current driver.
Dimming Controls	Dimming (0.1%, 1%), 0-10V, DALI, DMX, Hi-lume 1% are available. See Power Guide for details.
Input Voltage	120V - 277V, 50/60hz.
Power Location	Remote power. Maximum remote distance up to 100' (30.5m) depending on driver selection. See Power Guide for details.

Remote power is locating the power supply away from the fixture. Remote power comes in two housing styles: brick style and linear style. Consult [Power Guide](#) to determine which type you will receive.

Remote Brick Power Housing

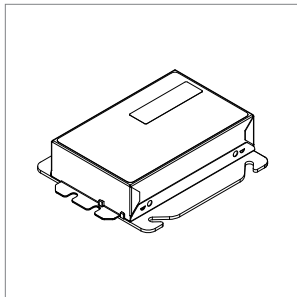

Supplied for some remote power applications. One remote power supply housing is supplied for each rail. Provided driver mounting plate fits standard 4" metal, square J-Boxes with a minimum volume of 21 in³ (J-Box not provided). See [Tech Sheet](#) for details.

Remote Linear Power Housing

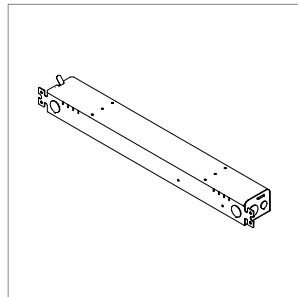

One remote power supply housing is supplied with each power supply. All Vode linear remote drivers come in a 0.054" (0.8mm) formed galvanized steel power supply housing with five (5) knockouts: (4) 1-1/8", (1) 7/8" and (1) 9/16". Accommodates standard linear power supplies. See [Tech Sheet](#) for details.

Wire Harness

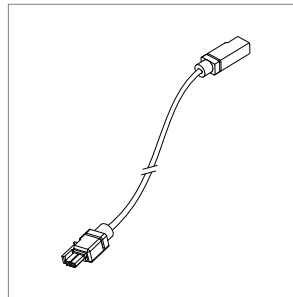

Wire harness connects driver to rail section. Lengths of 10' (3.0m) & 25' (7.6m) with snap-lock connectors for quick and easy installation. Multiple harnesses may be combined for lengths up to 100' (30.5m). See [Tech Sheet](#) for details.

Power and Controls

Flexible 1 to 1 power

For Flexible 1 to 1 Power, Vode supplies one single output driver per fixture, allowing each fixture to be controlled independently. Direct/Indirect fixtures are supplied with two single output drivers, allowing the direct and indirect lighting to be controlled independently. Consult [Power Guide](#) to determine which type you will receive.

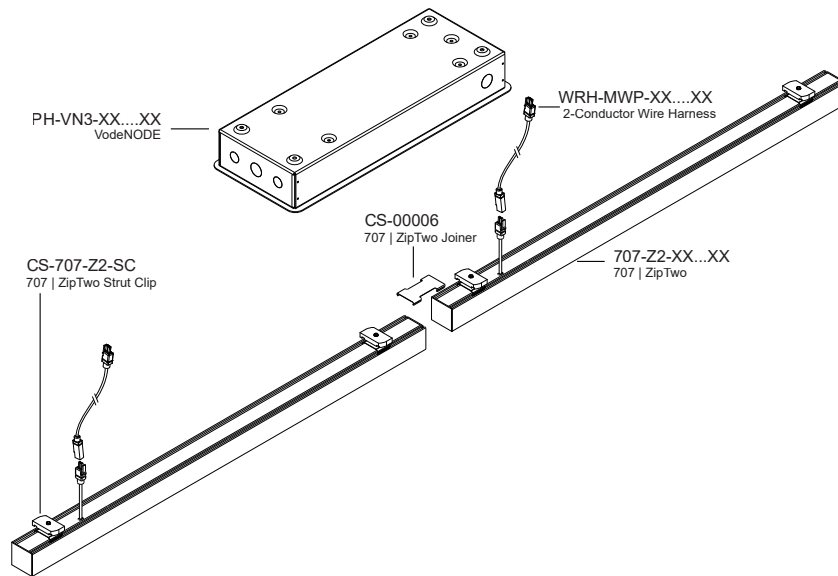

Optimized Power

To optimize power, Vode configures specifications with drivers that have 2 or 4 outputs. Depending on system configurations and power requirements, up to 4 fixtures can be powered from a 4-output driver. Consult [Power Guide](#) to determine which type you will receive.

IMPORTANT: Each fixture will still require individual wire harnesses, as shown below.

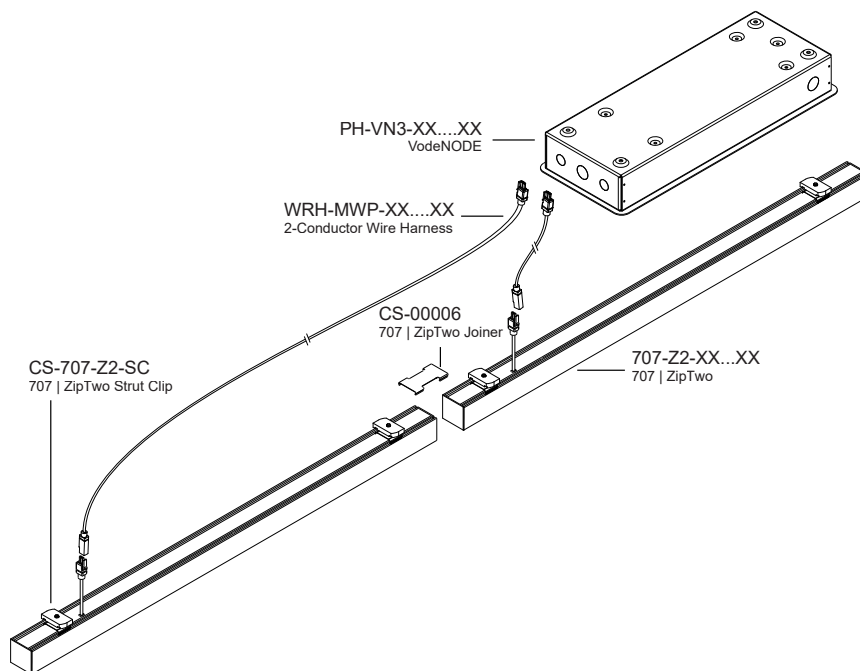

Note: Drawings not to scale, for reference only.

Dimensions

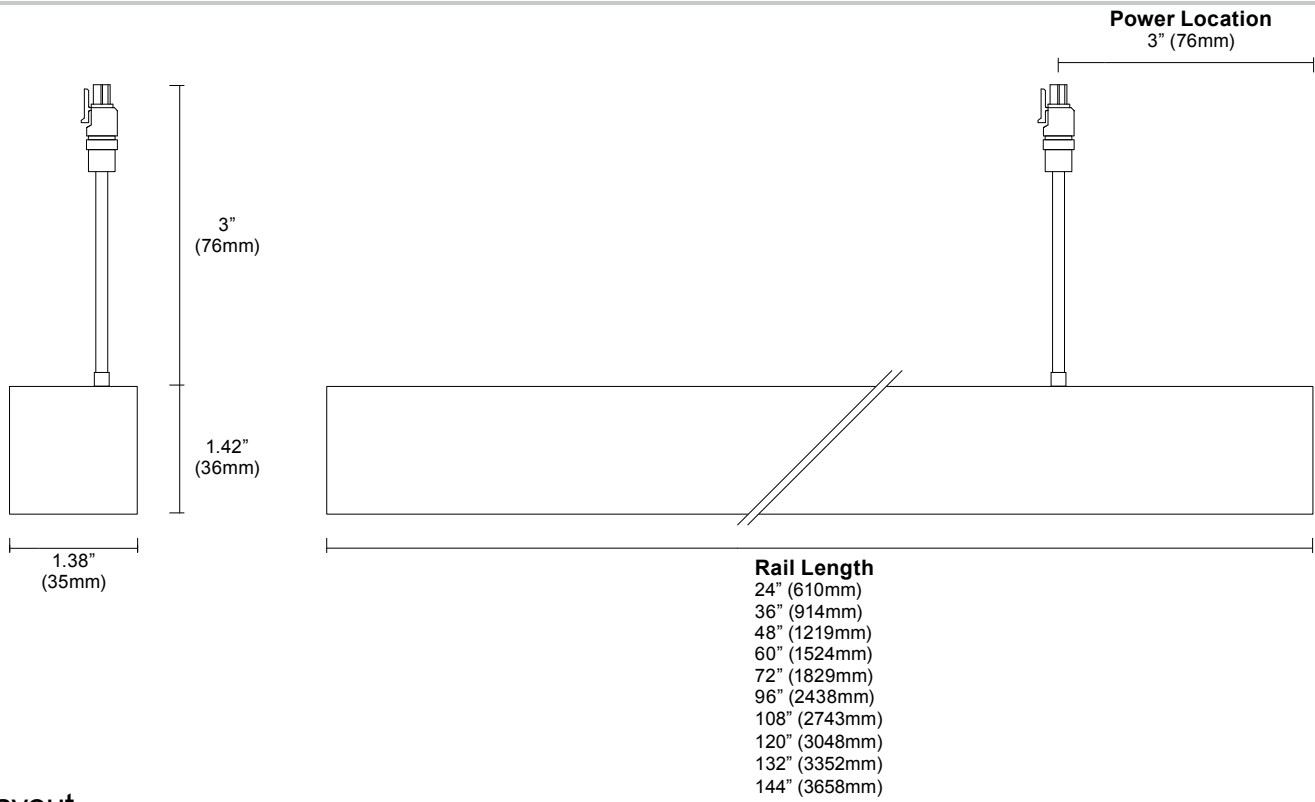

Layout

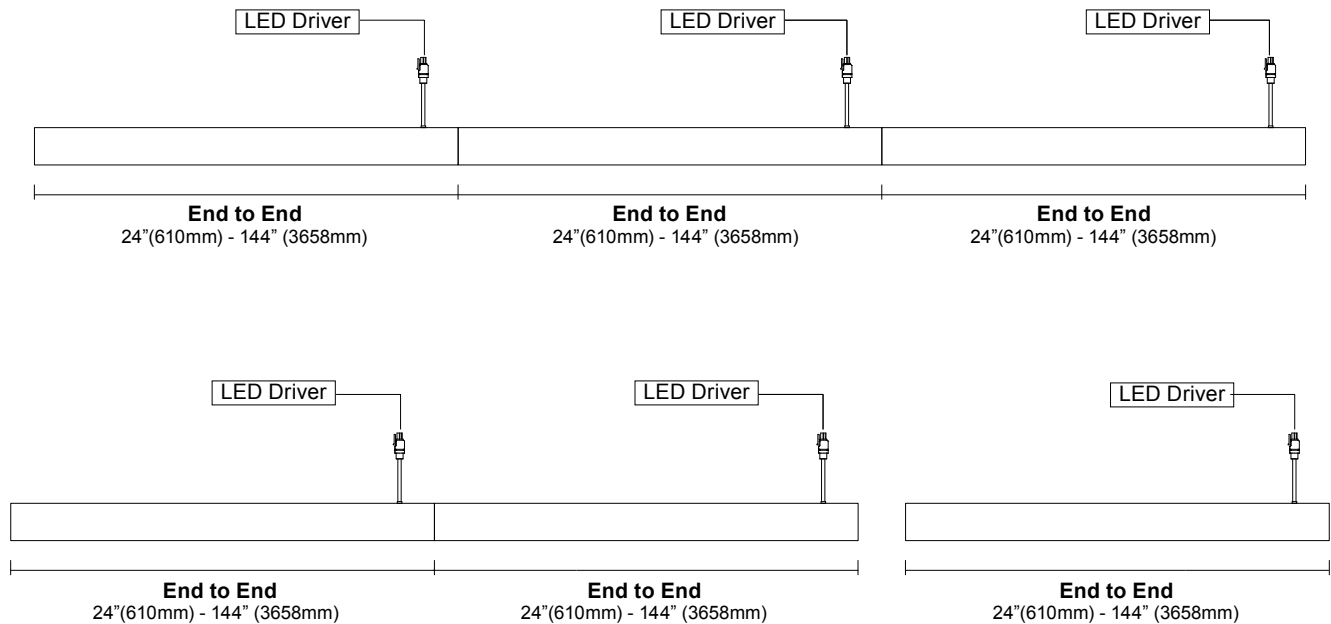

Corner and Shapes Available (Square, Rectangle, L-Shape, U-Shape, ZigZag) [See Guide](#) for details.

Mounting Options

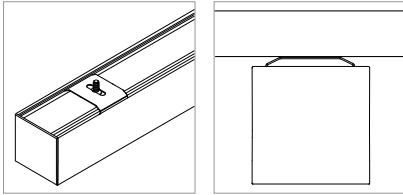

Clip (C)

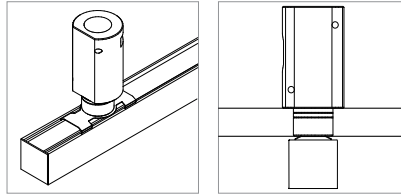

Clip with Micro J-Box (CM)

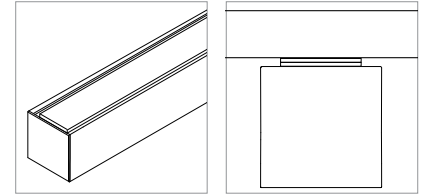

Magnet with Tape-On Metal Strip (T)

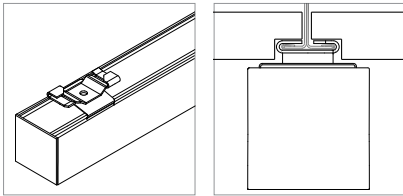

9/16" T-Bar Clip, low profile (T1)

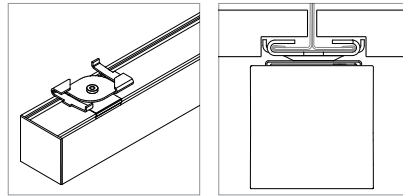

15/16" T-Bar Clip, low profile (T2)

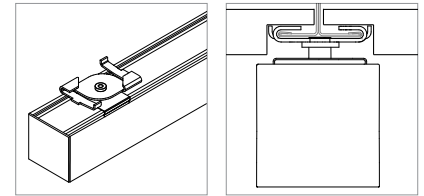

15/16" T-Bar Clip, medium profile (T3)

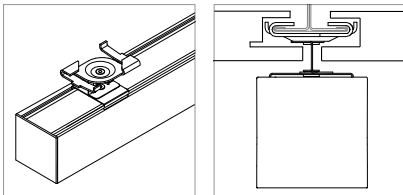

15/16" T-Bar Clip, concealed (T4)

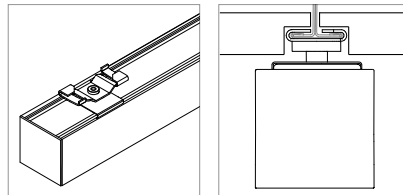

9/16" T-Bar Clip, medium profile (T5)

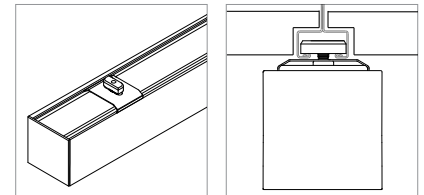

Slotted T-Bar Clip (T6)

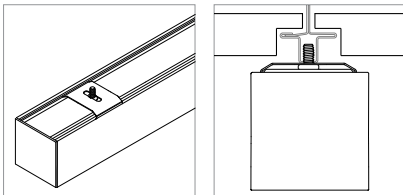

Dimensional T-Bar Clip (T7)

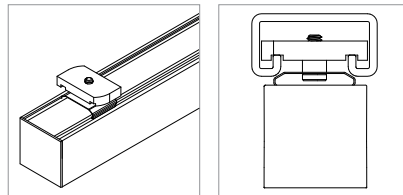

Strut Channel Clip (SC)

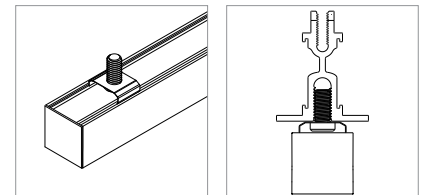

Armstrong DynaMax (DM)

See [ZipTwo Clip Guide](#) to check compatibility.

Performance | Zipper Board Optics

Zipper Board Optics design has 72 diodes per foot (305mm).

Square 3535, Asymmetric Wallwash, Graphite Baffle, White Finish (BAGB)

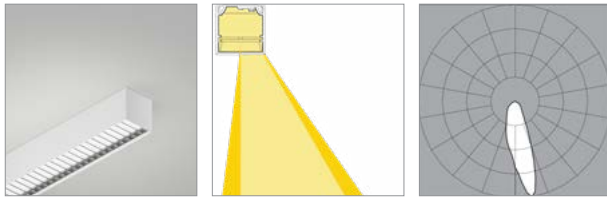

L80 >60,000 hours

80 CRI (80min., 84 avg.)

90 CRI (90min., 96 avg.)

Low Output (LO)

	2700K	3000K	3500K	4000K	2700K	3000K	3500K	4000K
Efficacy - Lumens per Watt	42	43	44	44	35	36	37	38
Lumens per foot (305mm)	137	141	144	144	115	119	121	122
Watts per foot (305mm)	3.3	3.3	3.3	3.3	3.3	3.3	3.3	3.3
Unified Glare Rating (UGR)	12.5	12.5	12.5	12.5	11.9	11.9	11.9	11.9

Standard Output (SO)

	2700K	3000K	3500K	4000K	2700K	3000K	3500K	4000K
Efficacy - Lumens per Watt	42	44	45	45	36	37	38	38
Lumens per foot (305mm)	274	282	288	288	230	237	242	244
Watts per foot (305mm)	6.6	6.6	6.6	6.6	6.6	6.6	6.6	6.6
Unified Glare Rating (UGR)	12.5	12.5	12.5	12.5	11.9	11.9	11.9	11.9

High Output (HO)

	2700K	3000K	3500K	4000K	2700K	3000K	3500K	4000K
Efficacy - Lumens per Watt	53	55	56	56	45	46	47	48
Lumens per foot (305mm)	520	536	547	547	437	451	460	464
Watts per foot (305mm)	9.9	9.9	9.9	9.9	9.9	9.9	9.9	9.9
Unified Glare Rating (UGR)	14.9	14.9	14.9	14.9	14.3	14.3	14.3	14.3

Square 3535, Asymmetric Wallwash, White Baffle, White Finish (BAWB)

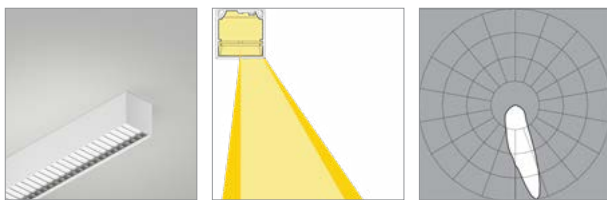

L80 >60,000 hours

80 CRI (80min., 84 avg.)

90 CRI (90min., 96 avg.)

Low Output (LO)

	2700K	3000K	3500K	4000K	2700K	3000K	3500K	4000K
Efficacy - Lumens per Watt	69	71	73	73	58	60	61	62
Lumens per foot (305mm)	226	233	238	238	190	196	200	202
Watts per foot (305mm)	3.3	3.3	3.3	3.3	3.3	3.3	3.3	3.3
Unified Glare Rating (UGR)	21.1	21.1	21.1	21.1	--	--	--	--

Standard Output (SO)

	2700K	3000K	3500K	4000K	2700K	3000K	3500K	4000K
Efficacy - Lumens per Watt	70	72	73	73	59	60	62	62
Lumens per foot (305mm)	452	467	476	476	380	392	400	404
Watts per foot (305mm)	6.6	6.6	6.6	6.6	6.6	6.6	6.6	6.6
Unified Glare Rating (UGR)	23.5	23.5	23.5	23.5	--	--	--	--

High Output (HO)

	2700K	3000K	3500K	4000K	2700K	3000K	3500K	4000K
Efficacy - Lumens per Watt	88	91	92	92	74	76	78	78
Lumens per foot (305mm)	860	887	905	905	722	745	760	768
Watts per foot (305mm)	9.9	9.9	9.9	9.9	9.9	9.9	9.9	9.9
Unified Glare Rating (UGR)	17.1	17.1	17.1	17.1	--	--	--	--

© 2024 Vode Lighting LLC. All rights reserved.

The Vode logo and Vode, ZipTwo, Zipper Board names are either registered trademarks or trademarks of Vode Lighting LLC in the United States and/or other countries. All other brand or product names are trademarks or registered trademarks of their respective owners. Due to ongoing innovation, specifications may change without notice.

Performance | Zipper Board Optics

Zipper Board Optics design has 72 diodes per foot (305mm).

Square 3535, 25° Symmetric, Graphite Baffle, White Finish (B1GB)

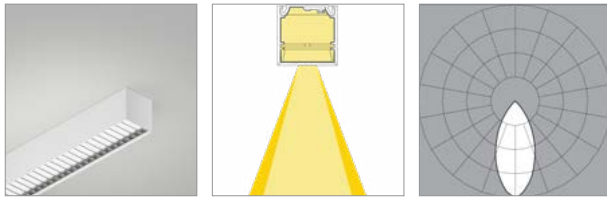

L80 >60,000 hours

80 CRI (80min., 84 avg.)

90 CRI (90min., 96 avg.)

	2700K	3000K	3500K	4000K	2700K	3000K	3500K	4000K
Low Output (LO)								
Efficacy - Lumens per Watt	41	42	43	43	34	35	36	36
Lumens per foot (305mm)	133	137	140	140	111	115	117	118
Watts per foot (305mm)	3.3	3.3	3.3	3.3	3.3	3.3	3.3	3.3
Unified Glare Rating (UGR)	11.1	11.1	11.1	11.1	10.5	10.5	10.5	10.5
Standard Output (SO)								
Efficacy - Lumens per Watt	41	42	43	43	35	36	36	37
Lumens per foot (305mm)	265	273	279	279	223	230	234	237
Watts per foot (305mm)	6.6	6.6	6.6	6.6	6.6	6.6	6.6	6.6
Unified Glare Rating (UGR)	13.5	13.5	13.5	13.5	12.9	12.9	12.9	12.9
High Output (HO)								
Efficacy - Lumens per Watt	52	53	54	54	43	45	46	46
Lumens per foot (305mm)	504	519	530	530	423	436	445	450
Watts per foot (305mm)	9.9	9.9	9.9	9.9	9.9	9.9	9.9	9.9
Unified Glare Rating (UGR)	15.8	15.8	15.8	15.8	15.2	15.2	15.2	15.2

Square 3535, 25° Symmetric, White Baffle, White Finish (B1WB)

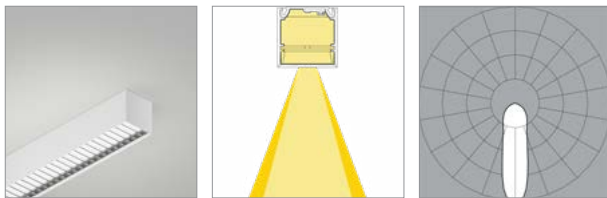

L90 >60,000 hours

80 CRI (80min., 84 avg.)

90 CRI (90min., 96 avg.)

	2700K	3000K	3500K	4000K	2700K	3000K	3500K	4000K
Low Output (LO)								
Efficacy - Lumens per Watt	61	63	64	64	51	53	54	55
Lumens per foot (305mm)	200	206	210	210	168	173	177	178
Watts per foot (305mm)	3.3	3.3	3.3	3.3	3.3	3.3	3.3	3.3
Unified Glare Rating (UGR)	17.3	17.3	17.3	17.3	16.7	16.7	16.7	16.7
Standard Output (SO)								
Efficacy - Lumens per Watt	61	63	64	64	51	53	54	55
Lumens per foot (305mm)	399	412	420	420	335	346	353	357
Watts per foot (305mm)	6.6	6.6	6.6	6.6	6.6	6.6	6.6	6.6
Unified Glare Rating (UGR)	19.7	19.7	19.7	19.7	19.1	19.1	19.1	19.1
High Output (HO)								
Efficacy - Lumens per Watt	78	80	82	82	65	67	69	69
Lumens per foot (305mm)	759	783	798	798	637	657	671	677
Watts per foot (305mm)	9.9	9.9	9.9	9.9	9.9	9.9	9.9	9.9
Unified Glare Rating (UGR)	21.9	21.9	21.9	21.9	21.4	21.4	21.4	21.4

© 2024 Vode Lighting LLC. All rights reserved.

The Vode logo and Vode, ZipTwo, Zipper Board names are either registered trademarks or trademarks of Vode Lighting LLC in the United States and/or other countries. All other brand or product names are trademarks or registered trademarks of their respective owners. Due to ongoing innovation, specifications may change without notice.

Performance | Zipper Board Optics

Zipper Board Optics design has 72 diodes per foot (305mm).

Square 3535, 60° Symmetric, Graphite Baffle, White Finish (B2GB)

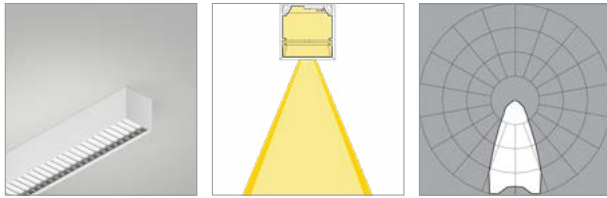

L80 >60,000 hours

80 CRI (80min., 84 avg.)

90 CRI (90min., 96 avg.)

	2700K	3000K	3500K	4000K	2700K	3000K	3500K	4000K
Low Output (LO)								
Efficacy - Lumens per Watt	42	44	44	44	36	37	37	38
Lumens per foot (305mm)	138	142	145	145	116	119	122	123
Watts per foot (305mm)	3.3	3.3	3.3	3.3	3.3	3.3	3.3	3.3
Unified Glare Rating (UGR)	13	13	13	13	12.4	12.4	12.4	12.4
Standard Output (SO)								
Efficacy - Lumens per Watt	43	44	45	45	36	37	38	38
Lumens per foot (305mm)	276	284	290	290	231	239	244	246
Watts per foot (305mm)	6.6	6.6	6.6	6.6	6.6	6.6	6.6	6.6
Unified Glare Rating (UGR)	15.4	15.4	15.4	15.4	14.8	14.8	14.8	14.8
High Output (HO)								
Efficacy - Lumens per Watt	54	55	56	56	45	47	47	48
Lumens per foot (305mm)	523	540	551	551	440	453	463	467
Watts per foot (305mm)	9.9	9.9	9.9	9.9	9.9	9.9	9.9	9.9
Unified Glare Rating (UGR)	17.6	17.6	17.6	17.6	17	17	17	17

Square 3535, 60° Symmetric, White Baffle, White Finish (B2WB)

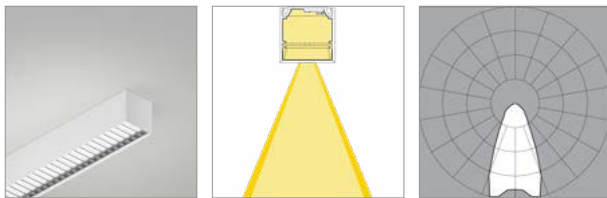

L90 >60,000 hours

80 CRI (80min., 84 avg.)

90 CRI (90min., 96 avg.)

	2700K	3000K	3500K	4000K	2700K	3000K	3500K	4000K
Low Output (LO)								
Efficacy - Lumens per Watt	64	66	67	67	54	55	57	57
Lumens per foot (305mm)	209	216	220	220	176	181	185	187
Watts per foot (305mm)	3.3	3.3	3.3	3.3	3.3	3.3	3.3	3.3
Unified Glare Rating (UGR)	17.5	17.5	17.5	17.5	16.9	16.9	16.9	16.9
Standard Output (SO)								
Efficacy - Lumens per Watt	64	66	67	67	54	55	57	57
Lumens per foot (305mm)	418	432	441	441	352	363	370	374
Watts per foot (305mm)	6.6	6.6	6.6	6.6	6.6	6.6	6.6	6.6
Unified Glare Rating (UGR)	19.9	19.9	19.9	19.9	19.3	19.3	19.3	19.3
High Output (HO)								
Efficacy - Lumens per Watt	81	84	85	85	68	70	72	73
Lumens per foot (305mm)	795	820	837	837	668	689	703	710
Watts per foot (305mm)	9.9	9.9	9.9	9.9	9.9	9.9	9.9	9.9
Unified Glare Rating (UGR)	22.1	22.1	22.1	22.1	21.5	21.5	21.5	21.5

© 2024 Vode Lighting LLC. All rights reserved.

The Vode logo and Vode, ZipTwo, Zipper Board names are either registered trademarks or trademarks of Vode Lighting LLC in the United States and/or other countries. All other brand or product names are trademarks or registered trademarks of their respective owners. Due to ongoing innovation, specifications may change without notice.

Performance | Zipper Board Optics

Zipper Board Optics design has 72 diodes per foot (305mm).

Square 3535, 120° Diffuse, Graphite Baffle, White Finish (B3GB)

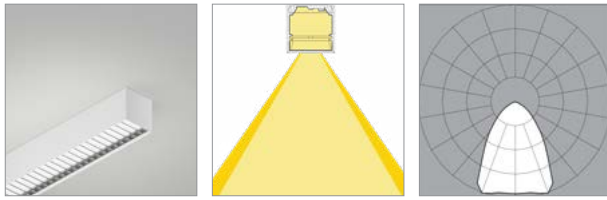

L80 >60,000 hours

80 CRI (80min., 84 avg.)

90 CRI (90min., 96 avg.)

Low Output (LO)

	2700K	3000K	3500K	4000K	2700K	3000K	3500K	4000K
Efficacy - Lumens per Watt	34	35	36	36	29	30	30	31
Lumens per foot (305mm)	111	115	117	117	93	96	98	99
Watts per foot (305mm)	3.3	3.3	3.3	3.3	3.3	3.3	3.3	3.3
Unified Glare Rating (UGR)	12.7	12.7	12.7	12.7	12.1	12.1	12.1	12.1

Standard Output (SO)

	2700K	3000K	3500K	4000K	2700K	3000K	3500K	4000K
Efficacy - Lumens per Watt	35	36	36	36	29	30	31	31
Lumens per foot (305mm)	222	229	234	234	187	193	197	198
Watts per foot (305mm)	6.6	6.6	6.6	6.6	6.6	6.6	6.6	6.6
Unified Glare Rating (UGR)	15.1	15.1	15.1	15.1	14.5	14.5	14.5	14.5

High Output (HO)

	2700K	3000K	3500K	4000K	2700K	3000K	3500K	4000K
Efficacy - Lumens per Watt	43	45	46	46	37	38	38	39
Lumens per foot (305mm)	422	436	445	445	355	366	373	377
Watts per foot (305mm)	9.9	9.9	9.9	9.9	9.9	9.9	9.9	9.9
Unified Glare Rating (UGR)	17.3	17.3	17.3	17.3	16.7	16.7	16.7	16.7

Square 3535, 120° Diffuse, White Baffle, White Finish (B3WB)

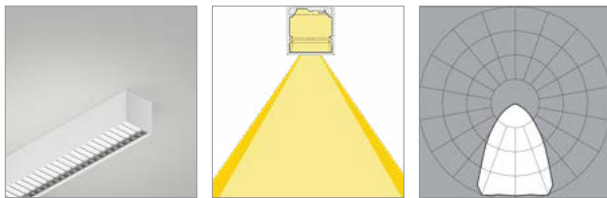

L80 >60,000 hours

80 CRI (80min., 84 avg.)

90 CRI (90min., 96 avg.)

Low Output (LO)

	2700K	3000K	3500K	4000K	2700K	3000K	3500K	4000K
Efficacy - Lumens per Watt	59	61	62	62	49	51	52	53
Lumens per foot (305mm)	192	198	202	202	162	167	170	172
Watts per foot (305mm)	3.3	3.3	3.3	3.3	3.3	3.3	3.3	3.3
Unified Glare Rating (UGR)	18.3	18.3	18.3	18.3	17.7	17.7	17.7	17.7

Standard Output (SO)

	2700K	3000K	3500K	4000K	2700K	3000K	3500K	4000K
Efficacy - Lumens per Watt	59	61	63	63	50	52	53	53
Lumens per foot (305mm)	385	397	405	405	323	333	340	343
Watts per foot (305mm)	6.6	6.6	6.6	6.6	6.6	6.6	6.6	6.6
Unified Glare Rating (UGR)	20.7	20.7	20.7	20.7	20.1	20.1	20.1	20.1

High Output (HO)

	2700K	3000K	3500K	4000K	2700K	3000K	3500K	4000K
Efficacy - Lumens per Watt	75	77	79	79	63	65	66	67
Lumens per foot (305mm)	731	754	769	769	614	633	646	652
Watts per foot (305mm)	9.9	9.9	9.9	9.9	9.9	9.9	9.9	9.9
Unified Glare Rating (UGR)	22.9	22.9	22.9	22.9	22.3	22.3	22.3	22.3

© 2024 Vode Lighting LLC. All rights reserved.

The Vode logo and Vode, ZipTwo, Zipper Board names are either registered trademarks or trademarks of Vode Lighting LLC in the United States and/or other countries. All other brand or product names are trademarks or registered trademarks of their respective owners. Due to ongoing innovation, specifications may change without notice.

Performance | Zipper Board Optics

Zipper Board Optics design has 72 diodes per foot (305mm).

Square 3535, Bisymmetric, Graphite Baffle, White Finish (B4GB)

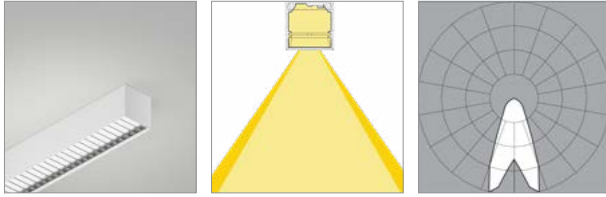

L90 >60,000 hours

80 CRI (80min., 84 avg.)

90 CRI (90min., 96 avg.)

	2700K	3000K	3500K	4000K	2700K	3000K	3500K	4000K
Low Output (LO)								
Efficacy - Lumens per Watt	42	43	44	44	36	37	37	38
Lumens per foot (305mm)	138	142	145	145	116	119	122	123
Watts per foot (305mm)	3.3	3.3	3.3	3.3	3.3	3.3	3.3	3.3
Unified Glare Rating (UGR)	11.4	11.4	11.4	11.4	10.8	10.8	10.8	10.8
Standard Output (SO)								
Efficacy - Lumens per Watt	43	44	45	45	36	37	38	38
Lumens per foot (305mm)	275	284	290	290	231	238	243	246
Watts per foot (305mm)	6.6	6.6	6.6	6.6	6.6	6.6	6.6	6.6
Unified Glare Rating (UGR)	13.8	13.8	13.8	13.8	13.2	13.2	13.2	13.2
High Output (HO)								
Efficacy - Lumens per Watt	54	55	56	56	45	46	47	48
Lumens per foot (305mm)	523	539	550	550	439	453	462	467
Watts per foot (305mm)	9.9	9.9	9.9	9.9	9.9	9.9	9.9	9.9
Unified Glare Rating (UGR)	16	16	16	16	15.4	15.4	15.4	15.4

Square 3535, Bisymmetric, White Baffle, White Finish (B4WB)

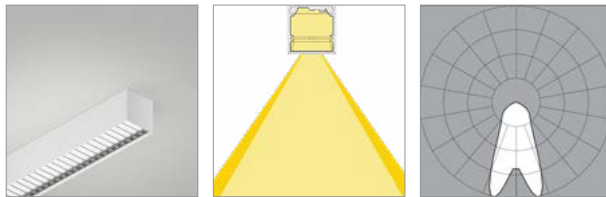

L80 >60,000 hours

80 CRI (80min., 84 avg.)

90 CRI (90min., 96 avg.)

	2700K	3000K	3500K	4000K	2700K	3000K	3500K	4000K
Low Output (LO)								
Efficacy - Lumens per Watt	64	66	68	68	54	56	57	57
Lumens per foot (305mm)	210	217	221	221	177	182	186	188
Watts per foot (305mm)	3.3	3.3	3.3	3.3	3.3	3.3	3.3	3.3
Unified Glare Rating (UGR)	11.4	11.4	11.4	11.4	10.8	10.8	10.8	10.8
Standard Output (SO)								
Efficacy - Lumens per Watt	64	66	68	68	54	56	57	57
Lumens per foot (305mm)	420	434	443	443	353	364	372	375
Watts per foot (305mm)	6.6	6.6	6.6	6.6	6.6	6.6	6.6	6.6
Unified Glare Rating (UGR)	13.8	13.8	13.8	13.8	13.2	13.2	13.2	13.2
High Output (HO)								
Efficacy - Lumens per Watt	82	84	86	86	69	71	72	73
Lumens per foot (305mm)	799	824	841	841	671	692	706	713
Watts per foot (305mm)	9.9	9.9	9.9	9.9	9.9	9.9	9.9	9.9
Unified Glare Rating (UGR)	16	16	16	16	15.4	15.4	15.4	15.4

© 2024 Vode Lighting LLC. All rights reserved.

The Vode logo and Vode, ZipTwo, Zipper Board names are either registered trademarks or trademarks of Vode Lighting LLC in the United States and/or other countries. All other brand or product names are trademarks or registered trademarks of their respective owners. Due to ongoing innovation, specifications may change without notice.

Performance | Zipper Board Optics

Zipper Board Optics design has 72 diodes per foot (305mm).

Square 3535, Asymmetric Wallwash, Graphite Baffle, Black Finish (BAGB)

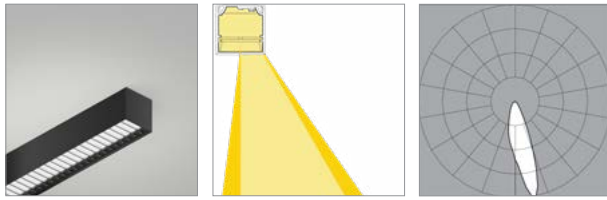

L80 >60,000 hours

	80 CRI (80min., 84 avg.)				90 CRI (90min., 96 avg.)			
	2700K	3000K	3500K	4000K	2700K	3000K	3500K	4000K
Low Output (LO)								
Efficacy - Lumens per Watt	33	34	34	34	27	28	29	29
Lumens per foot (305mm)	106	109	112	112	89	92	94	95
Watts per foot (305mm)	3.3	3.3	3.3	3.3	3.3	3.3	3.3	3.3
Unified Glare Rating (UGR)	5.4	5.4	5.4	5.4	4.8	4.8	4.8	4.8
Standard Output (SO)								
Efficacy - Lumens per Watt	33	34	35	35	28	29	29	30
Lumens per foot (305mm)	212	219	223	223	178	184	188	189
Watts per foot (305mm)	6.6	6.6	6.6	6.6	6.6	6.6	6.6	6.6
Unified Glare Rating (UGR)	7.8	7.8	7.8	7.8	7.2	7.2	7.2	7.2
High Output (HO)								
Efficacy - Lumens per Watt	41	43	44	44	45	46	47	48
Lumens per foot (305mm)	403	416	424	424	439	453	462	467
Watts per foot (305mm)	9.9	9.9	9.9	9.9	9.9	9.9	9.9	9.9
Unified Glare Rating (UGR)	10.1	10.1	10.1	10.1	9.5	9.5	9.5	9.5

Square 3535, 25° Symmetric, Graphite Baffle, Black Finish (B1GB)

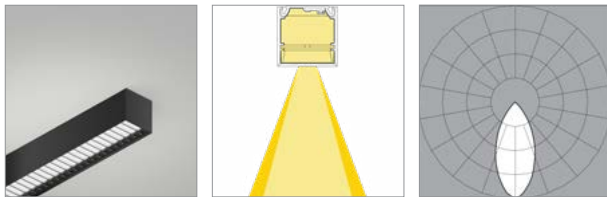

L90 >60,000 hours

	80 CRI (80min., 84 avg.)				90 CRI (90min., 96 avg.)			
	2700K	3000K	3500K	4000K	2700K	3000K	3500K	4000K
Low Output (LO)								
Efficacy - Lumens per Watt	29	30	30	30	24	25	26	26
Lumens per foot (305mm)	93	96	98	98	78	81	83	83
Watts per foot (305mm)	3.3	3.3	3.3	3.3	3.3	3.3	3.3	3.3
Unified Glare Rating (UGR)	3.3	3.3	3.3	3.3	2.7	2.7	2.7	2.7
Standard Output (SO)								
Efficacy - Lumens per Watt	29	30	30	30	24	25	26	26
Lumens per foot (305mm)	187	193	197	197	157	162	165	167
Watts per foot (305mm)	6.6	6.6	6.6	6.6	6.6	6.6	6.6	6.6
Unified Glare Rating (UGR)	5.7	5.7	5.7	5.7	5.1	5.1	5.1	5.1
High Output (HO)								
Efficacy - Lumens per Watt	37	38	38	38	31	32	32	33
Lumens per foot (305mm)	355	366	374	374	298	308	314	317
Watts per foot (305mm)	9.9	9.9	9.9	9.9	9.9	9.9	9.9	9.9
Unified Glare Rating (UGR)	8	8	8	8	7.4	7.4	7.4	7.4

© 2024 Vode Lighting LLC. All rights reserved.

The Vode logo and Vode, ZipTwo, Zipper Board names are either registered trademarks or trademarks of Vode Lighting LLC in the United States and/or other countries. All other brand or product names are trademarks or registered trademarks of their respective owners. Due to ongoing innovation, specifications may change without notice.

Performance | Zipper Board Optics

Zipper Board Optics design has 72 diodes per foot (305mm).

Square 3535, 60° Symmetric, Graphite Baffle, Black Finish (B2GB)

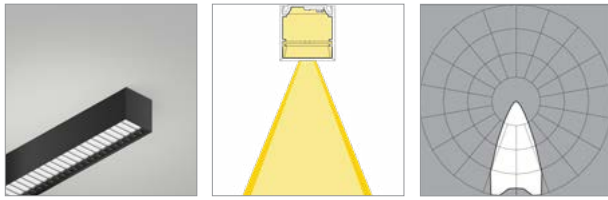

L80 >60,000 hours

80 CRI (80min., 84 avg.)

90 CRI (90min., 96 avg.)

Low Output (LO)

	2700K	3000K	3500K	4000K	2700K	3000K	3500K	4000K
Efficacy - Lumens per Watt	31	32	32	32	26	27	27	28
Lumens per foot (305mm)	100	103	105	105	84	86	88	89
Watts per foot (305mm)	3.3	3.3	3.3	3.3	3.3	3.3	3.3	3.3
Unified Glare Rating (UGR)	3.8	3.8	3.8	3.8	3.2	3.2	3.2	3.2

Standard Output (SO)

	2700K	3000K	3500K	4000K	2700K	3000K	3500K	4000K
Efficacy - Lumens per Watt	31	32	32	32	26	27	27	28
Lumens per foot (305mm)	200	206	210	210	168	173	177	178
Watts per foot (305mm)	6.6	6.6	6.6	6.6	6.6	6.6	6.6	6.6
Unified Glare Rating (UGR)	6.2	6.2	6.2	6.2	5.6	5.6	5.6	5.6

High Output (HO)

	2700K	3000K	3500K	4000K	2700K	3000K	3500K	4000K
Efficacy - Lumens per Watt	39	40	41	41	33	34	35	35
Lumens per foot (305mm)	380	391	399	399	319	329	335	339
Watts per foot (305mm)	9.9	9.9	9.9	9.9	9.9	9.9	9.9	9.9
Unified Glare Rating (UGR)	8.4	8.4	8.4	8.4	7.8	7.8	7.8	7.8

Square 3535, 120° Diffuse, Graphite Baffle, Black Finish (B3GB)

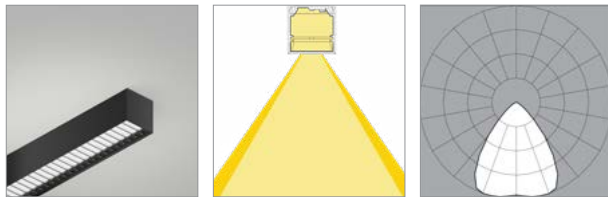

L90 >60,000 hours

80 CRI (80min., 84 avg.)

90 CRI (90min., 96 avg.)

Low Output (LO)

	2700K	3000K	3500K	4000K	2700K	3000K	3500K	4000K
Efficacy - Lumens per Watt	22	23	23	23	19	19	20	20
Lumens per foot (305mm)	71	74	75	75	60	62	63	64
Watts per foot (305mm)	3.3	3.3	3.3	3.3	3.3	3.3	3.3	3.3
Unified Glare Rating (UGR)	7.3	7.3	7.3	7.3	6.7	6.7	6.7	6.7

Standard Output (SO)

	2700K	3000K	3500K	4000K	2700K	3000K	3500K	4000K
Efficacy - Lumens per Watt	22	23	23	23	19	19	20	20
Lumens per foot (305mm)	143	147	151	151	120	124	127	128
Watts per foot (305mm)	6.6	6.6	6.6	6.6	6.6	6.6	6.6	6.6
Unified Glare Rating (UGR)	9.7	9.7	9.7	9.7	9.1	9.1	9.1	9.1

High Output (HO)

	2700K	3000K	3500K	4000K	2700K	3000K	3500K	4000K
Efficacy - Lumens per Watt	28	29	30	30	24	24	25	25
Lumens per foot (305mm)	272	280	286	286	228	236	240	243
Watts per foot (305mm)	9.9	9.9	9.9	9.9	9.9	9.9	9.9	9.9
Unified Glare Rating (UGR)	12	12	12	12	11.4	11.4	11.4	11.4

© 2024 Vode Lighting LLC. All rights reserved.

The Vode logo and Vode, ZipTwo, Zipper Board names are either registered trademarks or trademarks of Vode Lighting LLC in the United States and/or other countries. All other brand or product names are trademarks or registered trademarks of their respective owners. Due to ongoing innovation, specifications may change without notice.

Performance | Zipper Board Optics

Zipper Board Optics design has 72 diodes per foot (305mm).

Square 3535, Bisymmetric, Graphite Baffle, Black Finish (B4GB)

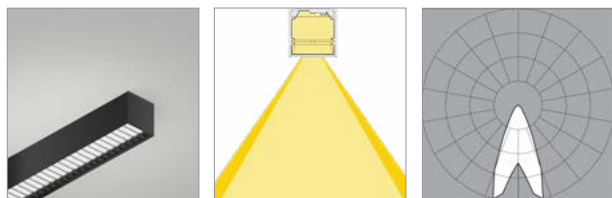

L80 >60,000 hours

80 CRI (80min., 84 avg.)

90 CRI (90min., 96 avg.)

	80 CRI (80min., 84 avg.)				90 CRI (90min., 96 avg.)			
	2700K	3000K	3500K	4000K	2700K	3000K	3500K	4000K
Low Output (LO)								
Efficacy - Lumens per Watt	33	34	35	35	28	29	29	30
Lumens per foot (305mm)	108	111	113	113	90	93	95	96
Watts per foot (305mm)	3.3	3.3	3.3	3.3	3.3	3.3	3.3	3.3
Unified Glare Rating (UGR)	4.1	4.1	4.1	4.1	4.1	4.1	4.1	4.1
Standard Output (SO)								
Efficacy - Lumens per Watt	34	35	35	35	28	29	30	30
Lumens per foot (305mm)	215	222	227	227	181	187	191	192
Watts per foot (305mm)	6.6	6.6	6.6	6.6	6.6	6.6	6.6	6.6
Unified Glare Rating (UGR)	6.5	6.5	6.5	6.5	5.9	5.9	5.9	5.9
High Output (HO)								
Efficacy - Lumens per Watt	42	43	44	44	35	37	37	38
Lumens per foot (305mm)	409	422	431	431	344	355	362	366
Watts per foot (305mm)	9.9	9.9	9.9	9.9	9.9	9.9	9.9	9.9
Unified Glare Rating (UGR)	6.5	6.5	6.5	6.5	8.2	8.2	8.2	8.2

© 2024 Vode Lighting LLC. All rights reserved.

The Vode logo and Vode, ZipTwo, Zipper Board names are either registered trademarks or trademarks of Vode Lighting LLC in the United States and/or other countries. All other brand or product names are trademarks or registered trademarks of their respective owners. Due to ongoing innovation, specifications may change without notice.