



Spec Guide

ZipThree® | Ceiling Cable | 707



Direct/indirect lighting for ambient, open office and conference room applications.



ZipThree, Symmetric with EdgeGlow, Uplight

Benefits & Features

Micro Profile, Robust Design

Flat profile, 0.35" (9mm) x 3.78" (96mm)

Superior Light Quality & Performance

Outputs up to: 3154 lm/ft (10,349 lm/m), 130 lm/W (SO). 80 or 90 CRI & tunable white (2200K-6500K) available.

Remote Power with Independent Channel Control

Power may be located up to 72' (22m) away. Direct/indirect circuits may be independently controlled.

A Floating Line of Light with EdgeGlow™ and Multiple Optics.

A wide variety of optics available for direct and indirect applications. Optional EdgeGlow™ for edge-lit detail.

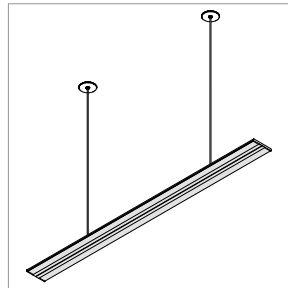

Small Round Canopy

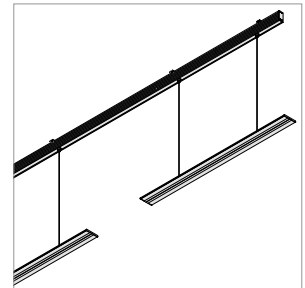

Multiple Fixtures with Integral Bus

Build Your Specification

707-Z3			CC ▶▶
---------------	--	--	--------------

System & Rail Type	System Type	System Length	Rail Length	Mounting
707-Z3 ZipThree	SF Single Fixture MF Multiple Fixtures with Integral Bus	Single Fixture 2 2' (610mm) ¹ 3 3' (914mm) ¹ 4 4' (1219mm) 5 5' (1524mm) 6 6' (1829mm) 8 8' (2438mm) ZZ Other rail length or layout (please specify)	Single Fixture 24 24" (610mm) ¹ 36 36" (914mm) ¹ 48 48" (1219mm) 60 60" (1524mm) 72 72" (1829mm) 96 96" (2438mm) ZZ Other rail length or layout (please specify)	CC Ceiling Cable
	Multiple Fixtures with Integral Bus Specify overall system length in ft/in or M/mm.		Multiple Fixtures with Integral Bus SC SubCode (please specify below) See page 7 for more details. See Rail Length Chart for more details.	

▲ Custom lengths may result in light gaps on the fixture. See [Rail Length Chart](#) for more details.

--	--	--	--

Cord Length	Power Location	Power Type	Voltage
48 48" cord (1219mm) 96 96" cord (2438mm) ZZ Other (please specify)	Remote Power Specify mounting and harness length code example: 2R25, 2R50 ...etc. Mounting Option 2R Small Round Canopy Wire Harness 10 10' (3.048m) Wire Harness 25 25' (7.62m) Wire Harness 50 50' (15.24m) Wire Harness 75 75' (22.86m) Wire Harness 100 100' (30.48m) Wire Harness	Flexible 1 to 1 Power AE 0-10V, 1.0% Dimming AT 0-10V, 0.1% Dimming AD DALI, 0.1% Dimming AX DMX, 100-0% Dimming AH Hi-lume 1% EcoSystem, Soft On / Fade to Black Technology, LDE ¹ AH2 ELV 1% 2-wire (Forward and Reverse Phase)	1 120V 2 120V - 277V X Not Yet Specified
		Optimized Power Add 'O' to power type example: AEO, ATO...etc. ² VodeNODE Add 'N' to power type for Flexible 1 to 1 Power Add 'ON' to power type for Optimized Power example: AEN, ATN, AEON, ADON...etc. ³ ZZ Other (please specify) See Power Guide for driver features & limitations.	

	Z		
--	----------	--	--

Emergency Power	LED Type	Lumen Output	Color Temperature	Optics
0 No Emergency ZZ Power Emergency Power (specify requirements)	Z Zipper Board	LO Low Output SO Standard Output HO High Output ⁴ ZZ Other (please specify) See IES Files page for details. See Power Guide for driver features & limitations.	80+ CRI 27 2700K 30 3000K 35 3500K 40 4000K 90+ CRI 279 2700K 309 3000K 359 3500K 409 4000K ZZ Tunable White Available See Guide for details	U1S1 Symmetric, up 40° Symmetric, down U1S2 Symmetric, up 60° Symmetric, down U1S7 Symmetric, up 80° Symmetric, down U1D2 Symmetric, up Soft Diffuse, down U2S1 Symmetric with EdgeGlow, up 40° Symmetric, down U2S2 Symmetric with EdgeGlow, up 60° Symmetric, down U2S7 Symmetric with EdgeGlow, up 80° Symmetric, down U2D2 Symmetric with EdgeGlow, up Soft Diffuse, down

--	--	--

Sensors	Finish	Options
0 None ZZ Sensor (specify requirements)	AL Clear Anodized WH White Painted BL Black Anodized	0 None EF End Feed Kit ⁴ 9 9' 18/3 Cord and Plug ⁵

NOTES & LIMITATIONS

- ¹ 24" & 36" fixtures available in remote power only.
- ² Optimized Power is not available with Hi-lume 1% EcoSystem (AHO) Power Type.
- ³ VodeNODE enclosure is not available with ELV 1% 2-wire (AH2) Power Type.
- ⁴ Provides input/output through end of integral bus. Integral Power (IP) only.
- ⁵ 9' 18/3 Cord and Plug only available with Remote Power (RP)

Listed to UL standards for damp location by a Nationally Recognized Testing Laboratory (NRTL) recognized by OSHA. Certain limitations exist for each Certification. Contact factory for verification.

Standard 5 Year Limited Warranty. See details [here](#). Contact factory for options on Limited Warranties up to 20 years.



Applications

General Interior and Open Office



Atlassian, Mountain View, CA

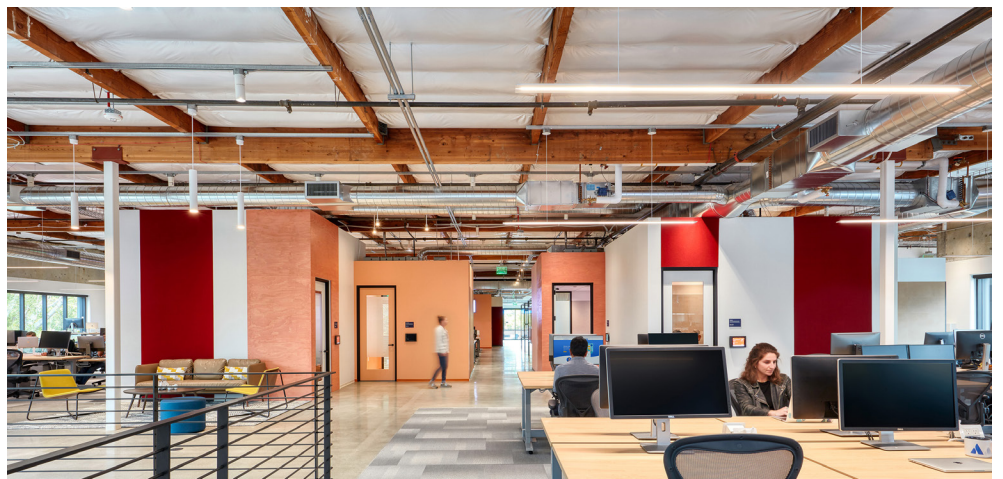

Atlassian, Mountain View, CA

Declare Label

All Vode Lighting linear light fixtures proudly carry the Red List Approved designation.

See [International Living Future Institute](https://www.livingfuture.org) website for details.

Declare.



Vode Adaptive Architectural Lighting Systems

Vode Lighting LLC

Final Assembly: Sonoma, California, US

Life Expectancy: 10+ Year(s)

End of Life Options: Recyclable (100%)

Ingredients:

Anodized Aluminum (6063-T5 Alloy); Steel; Small Electrical Component (RoHS)¹; Copper; **Fluorinated Ethylene Propylene (masterbatch)**²; Polymethyl methacrylate (PMMA); Stainless Steel; Polyoxymethylene Copolymer (POM); Styrene-butadiene polymer, hydrogenated; Poly(methyl methacrylate/butyl acrylate/styrene) (PMMA/BA/S); Styrene/butadiene copolymer; Distillates; Polypropylene; Calcium carbonate; Polycarbonate; EVA Copolymer; Methyl methacrylate (MMA); Polyphenylene Oxide; Brass; Tin, Organic

¹LBC Temp Exception RL-002 - Small Electrical Components

²LBC Temp Exception RL-023 - Wire Sheathing Subject to NFPA 90A, NFPA 262, UL[®] 910

Living Building Challenge Criteria: Compliant

I-13 Red List:

- LBC Red List Free % Disclosed: 100% at 100ppm
- LBC Red List Approved VOC Content: Not Applicable
- Declared

I-10 Interior Performance: Not Applicable

I-14 Responsible Sourcing: Not Applicable

VDE-0001

EXP. 01 JAN 2025

Original Issue Date: 2018

MANUFACTURER RESPONSIBLE FOR LABEL ACCURACY
INTERNATIONAL LIVING FUTURE INSTITUTE™ [living-future.org/declare](https://www.living-future.org/declare)

Structure

Rail Lengths	24" (610mm) - 96" (2438mm). Modified lengths available. See Rail Length Chart for more details.
Rail Dimensions	Rectangular profile, 0.35" (9mm) x 3.78" (96mm) x length.
Construction	Extruded and machined 6063 aluminum.
Mounting	Ceiling mount to jbox or integral bus.
System Run Length	24" (610mm) minimum. Unlimited maximum.
Operating Temperature	32°F to 95°F (0°C to 35°C).
Humidity	0-85%, non-condensing.
System Weight	0.65 lbs per ft (0.29kg per 305mm). Power supply and housing not included.

Materials

LED Board Construction	Aluminum core PCB, LCP connectors, RoHS compliant.
Lenses	High impact extruded acrylic glass (PMMA).
Suspension Cables	Ø4mm, 24/4 AWG, PVC or TPE and RoHS compliant (<i>PVC free in 2020</i>)
Power Cables	18/2 AWG, Plenum (CMP) rated semi-rigid PVC or FEP, flame tested UL-910 (<i>PVC free in 2020</i>)
Cable Connectors	Unfilled black nylon, rated UL 94 V-0, halogen free, PVC or FEP overmold, RoHS compliant (<i>PVC free in 2020</i>)
Remote Linear Power Housing (RLP)	20.7" x 2.375" x 2.53", 0.054" formed Galvanized Steel
Remote Brick Power Housing (RBP)	4.32" x 3.37" x .078" Galvanized Steel mounting plate
Integral Bus Housing	2.75"x1.4", extruded and machined 6063 aluminum.

Dimensions

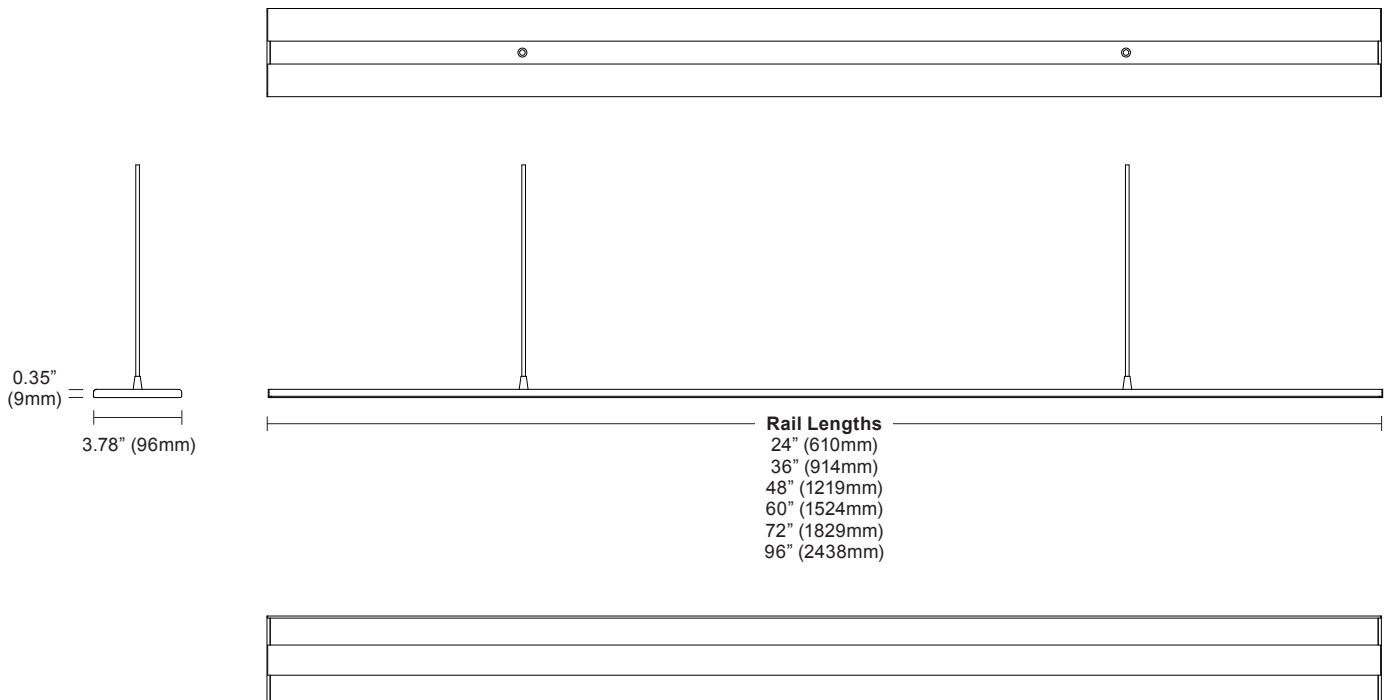

Remote Power Layout

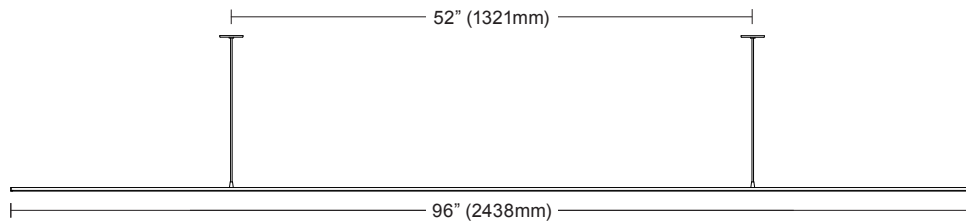
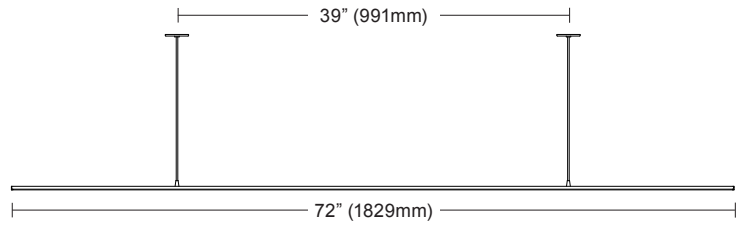
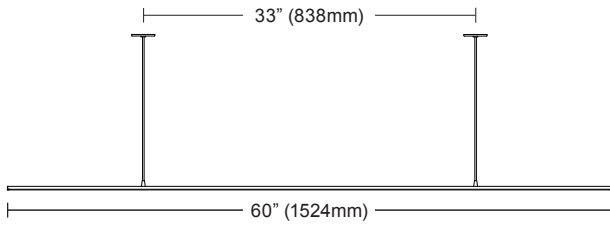
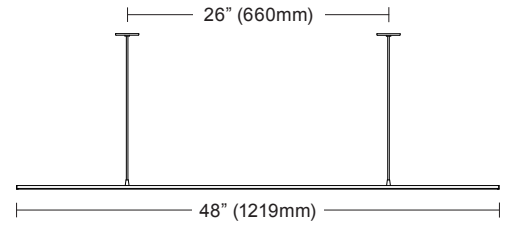
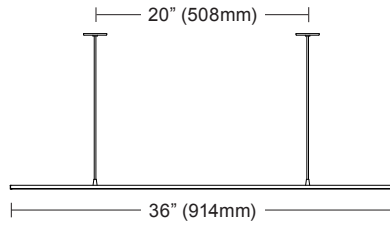
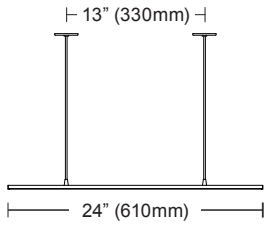

Integral Power Layout

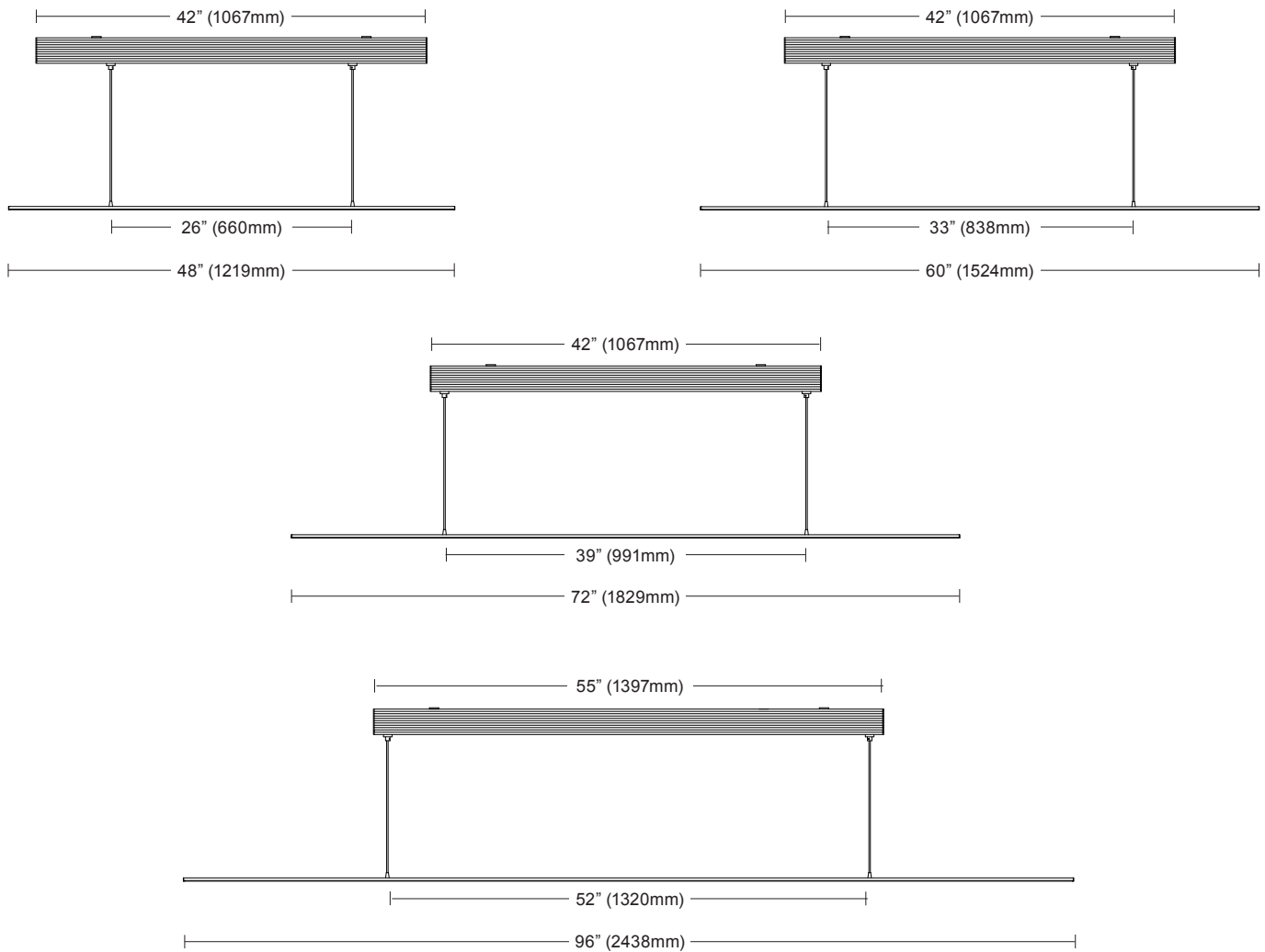

NOTES & LIMITATIONS

24" & 36" fixtures available in remote power only.

Mounting Options

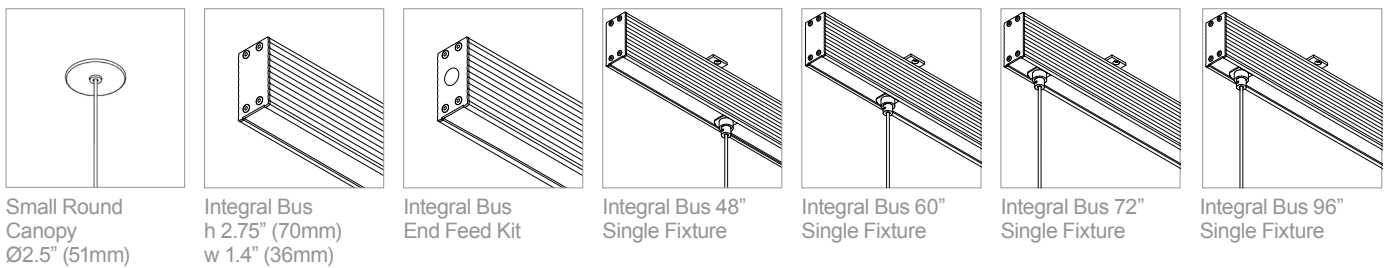

Specifying Multiple Fixtures with Integral Bus

The Integral Bus system is a single, linear enclosure that houses all drivers and electrical connections for multiple suspended ZipThree fixtures. It attaches directly to a concrete, wood or drywall ceiling. Multiple fixtures can be installed quickly and precisely with a single line voltage feed through the top or end cap. The Integral Bus system typically runs the entire length of the fixtures and gaps, however a longer bus may be specified, if desired. Maximum length of individual Bus sections is 12' (3658mm). Please specify shorter lengths, if desired.

How to Specify:

1. **System Type:** select "Multiple Fixtures with Integral Bus" (MF).
2. **Overall System Length:** specify the total length of all rails and gaps. Vode recommends a minimum 6" gap between rails. Standard gap lengths are in 6" increments.
3. **Rail Length:** select "SubCode" (SC). In the SubCode field, specify the length of each rail and gap. Use the prefix "G" to specify gaps.
4. **Options:** select "End Feed Kit" (EF) for end feed installations.

Example 1:

Overall System Length: 24'

Rail Length SubCode: G36", 60", G36", 60", G36", 60"

Example 2:

Overall System Length: 21'

Rail Length SubCode: 60", G36", 60", G36", 60"

NOTE: total length of all rails and gaps must be equal to or less than "Overall System Length". Integral Bus system may start and/or end with a gap, if desired.

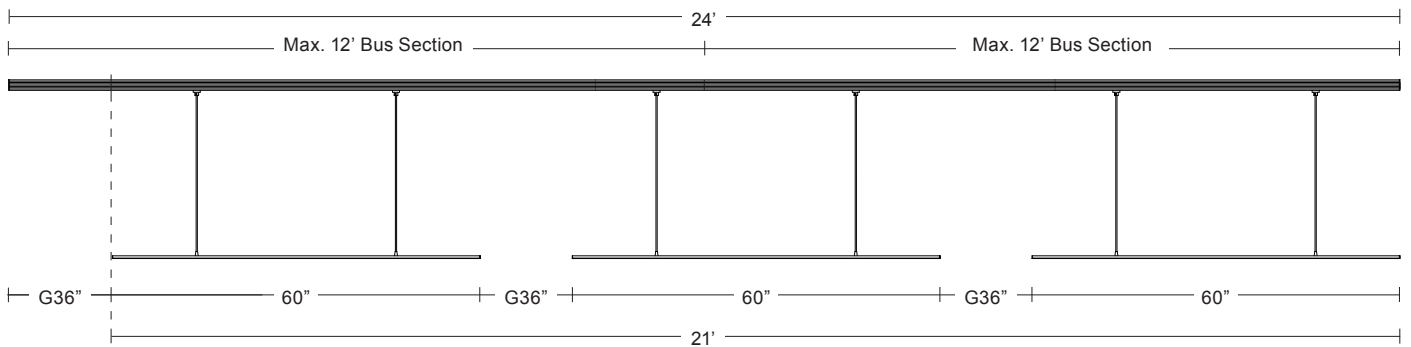

Power and Controls

Power Type	Class 2 (<60V output) constant current driver
Dimming Controls	Dimming (0.1%, 1%), 0-10V, DALI, DMX, Hi-lume 1% are available. See Power Guide for details.
Input Voltage	120V - 277V, 50/60hz
Power Location	Integral or remote power. Maximum remote distance up to 100' (30.5m) depending on driver selection. See Power Guide for details.

Vode power locations fall into two categories: integral and remote. Remote power is locating the power supply away from the fixture. Remote power comes in two housing styles: brick style and linear style. Consult [Power Guide](#) to determine which type you will receive. Integral power is locating the power supply into the lighting fixture or mounting.

Remote Brick Power Housing

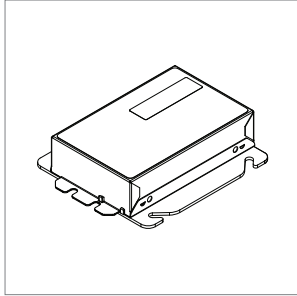

Supplied for some remote power applications. One remote power supply housing is supplied for each rail. Provided driver mounting plate fits standard 4" metal, square J-Boxes with a minimum volume of 21 in³ (J-Box not provided). See [Tech Sheet](#) for details.

Remote Linear Power Housing

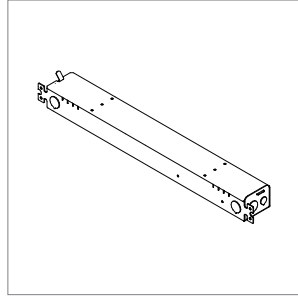

One remote power supply housing is supplied with each power supply. All Vode linear remote drivers come in a 0.054" (0.8mm) formed galvanized steel power supply housing with five (5) knockouts: (4) 1-1/8", (1) 7/8" and (1) 9/16". Accommodates standard linear power supplies. See [Tech Sheet](#) for details.

Integral Power

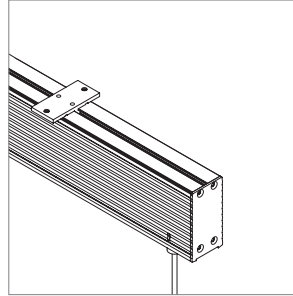

Houses integral power supply. Mounts to most surfaces. Blocking or engineered anchors required. See [Tech Sheet](#) for details.

Wire Harness

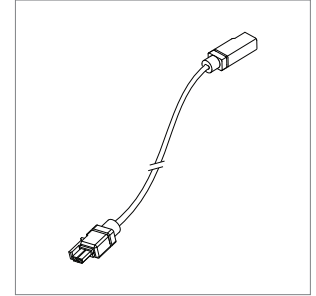

Wire harness connects driver to rail section. Lengths of 10' (3.0m) & 25' (7.6m) with snap-lock connectors for quick and easy installation. Multiple harnesses may be combined for lengths up to 100' (30.5m). See [Tech Sheet](#) for details.

Power and Controls

Flexible 1 to 1 power

For Flexible 1 to 1 Power, Vode supplies one single output driver per fixture, allowing each fixture to be controlled independently. Direct/Indirect fixtures are supplied with two single output drivers, allowing the direct and indirect lighting to be controlled independently. Consult [Power Guide](#) to determine which type you will receive.

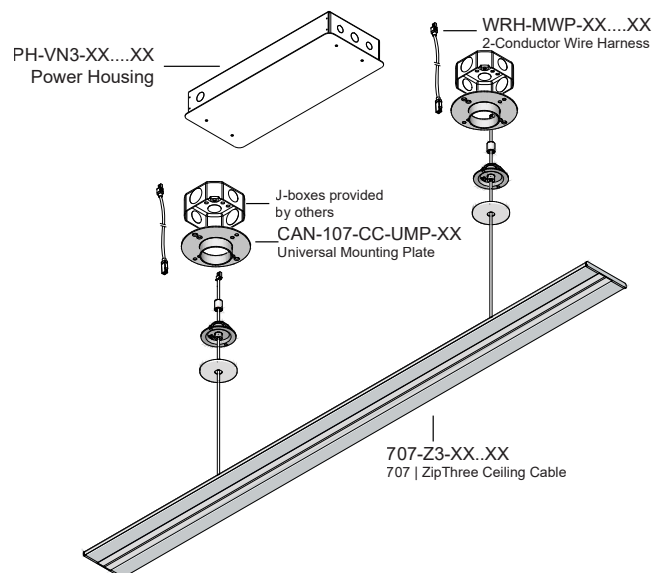

Note: Drawings not to scale, for reference only.

Power and Controls

Optimized Power

To optimize power, Vode configures specifications with drivers that have 2 or 4 outputs. Depending on system configurations and power requirements, up to 4 fixtures can be powered from a 4-output driver. Consult [Power Guide](#) to determine which type you will receive.

IMPORTANT: Each fixture will still require individual wire harnesses, as shown below.

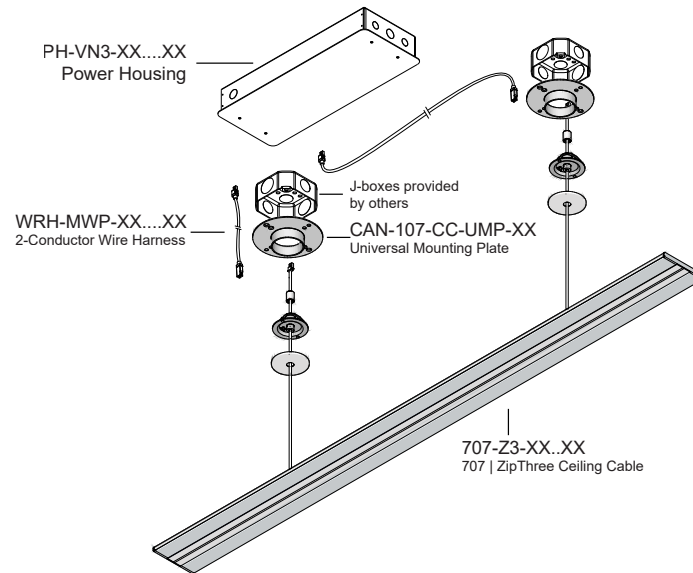

Note: Drawings not to scale, for reference only.

Finish

Clear Anodized Finish



Clear Anodized Rail, White Canopy or Clear Anodized Integral Bus, Clear Cable

Black Anodized Finish

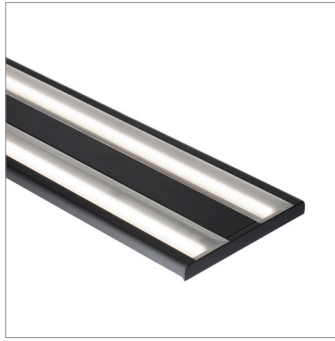

Black Rail, Black Canopy or Integral Bus, Black Cable

White Painted Finish



White Rail, White Canopy or Integral Bus, White Cable

Performance | Zipper Board Optics

Zipper Board Optics design has 72 diodes per foot (305mm).

Symmetric, up | 40° Symmetric, down (U1S1)

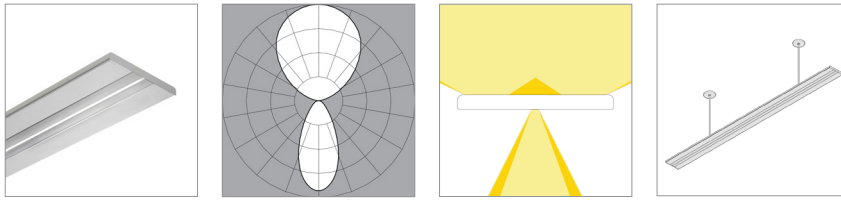

L80 >60,000 hours

	80 CRI (80min., 84 avg.)				90 CRI (90min., 96 avg.)			
	2700K	3000K	3500K	4000K	2700K	3000K	3500K	4000K
Low Output (LO)								
Efficacy - Lumens per Watt	91	94	96	96	79	81	83	84
Lumens per foot (305mm)	675	697	711	711	582	601	613	619
Watts per foot (305mm)	7.5	7.5	7.5	7.5	7.5	7.5	7.5	7.5
Standard Output (SO)								
Efficacy - Lumens per Watt	104	107	109	109	90	92	95	95
Lumens per foot (305mm)	1351	1393	1422	1442	1165	1201	1226	1238
Watts per foot (305mm)	13.1	13.1	13.1	13.1	13.1	13.1	13.0	13.1
High Output (HO)								
Efficacy - Lumens per Watt	96	99	101	101	83	85	87	88
Lumens per foot (305mm)	2567	2648	2702	2702	2213	2282	2329	2352
Watts per foot (305mm)	27.0	27.0	27.0	27.0	27.0	27.0	27.0	27.0

Symmetric, up | 60° Symmetric, down (U1S2)

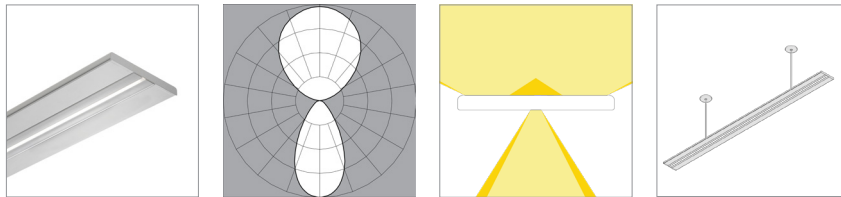

L80 >60,000 hours

	80 CRI (80min., 84 avg.)				90 CRI (90min., 96 avg.)			
	2700K	3000K	3500K	4000K	2700K	3000K	3500K	4000K
Low Output (LO)								
Efficacy - Lumens per Watt	105	108	110	110	91	93	95	99
Lumens per foot (305mm)	777	802	818	818	670	691	705	712
Watts per foot (305mm)	7.5	7.5	7.5	7.5	7.5	7.5	7.5	7.5
Standard Output (SO)								
Efficacy - Lumens per Watt	120	123	126	126	104	107	109	113
Lumens per foot (305mm)	1555	1604	1636	1636	1340	1382	1411	1425
Watts per foot (305mm)	13.1	13.1	13.1	13.1	13.0	13.0	13.0	13.0
High Output (HO)								
Efficacy - Lumens per Watt	110	114	116	116	95	98	100	104
Lumens per foot (305mm)	2954	3047	3109	3109	2546	2627	2680	2707
Watts per foot (305mm)	27.0	27.0	27.0	27.0	27.0	27.0	27.0	27.0

Performance | Zipper Board Optics

Zipper Board Optics design has 72 diodes per foot (305mm).

Symmetric, up | 80° Symmetric, down (U1S7)

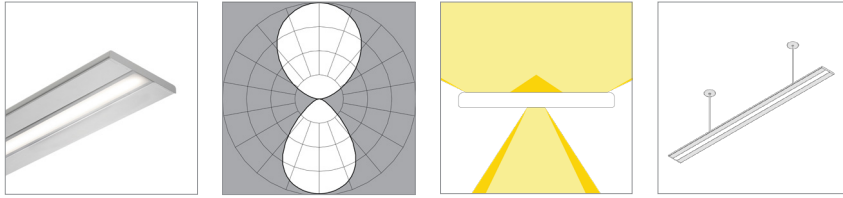

L80 >60,000 hours

	80 CRI (80min., 84 avg.)				90 CRI (90min., 96 avg.)			
	2700K	3000K	3500K	4000K	2700K	3000K	3500K	4000K
Low Output (LO)								
Efficacy - Lumens per Watt	110	113	116	116	95	98	100	104
Lumens per foot (305mm)	815	841	858	858	703	725	740	747
Watts per foot (305mm)	7.5	7.5	7.5	7.5	7.5	7.5	7.5	7.5
Standard Output (SO)								
Efficacy - Lumens per Watt	125	129	132	132	109	113	115	120
Lumens per foot (305mm)	1630	1682	1716	1716	1405	1450	1479	1494
Watts per foot (305mm)	13.1	13.1	13.1	13.1	13.0	13.0	13.0	13.0
High Output (HO)								
Efficacy - Lumens per Watt	116	119	122	122	100	103	105	109
Lumens per foot (305mm)	3097	3195	3260	3260	2670	2754	2810	2839
Watts per foot (305mm)	27.0	27.0	27.0	27.0	27.0	27.0	27.0	27.0

Symmetric, up | Soft Diffuse, down (U1D2)

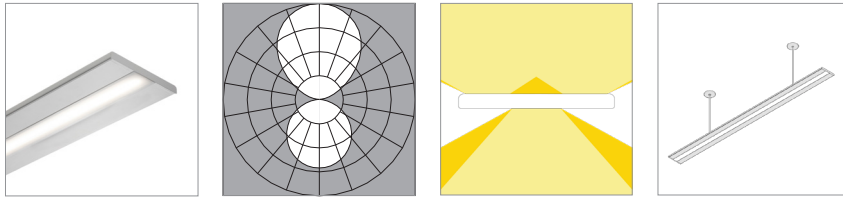

L80 >60,000 hours

	80 CRI (80min., 84 avg.)				90 CRI (90min., 96 avg.)			
	2700K	3000K	3500K	4000K	2700K	3000K	3500K	4000K
Low Output (LO)								
Efficacy - Lumens per Watt	114	118	120	120	99	102	104	105
Lumens per foot (305mm)	847	874	892	892	730	753	769	776
Watts per foot (305mm)	7.5	7.5	7.5	7.5	7.5	7.5	7.5	7.5
Standard Output (SO)								
Efficacy - Lumens per Watt	130	134	137	137	122	116	119	119
Lumens per foot (305mm)	1694	1748	1783	1783	1461	1507	1537	1553
Watts per foot (305mm)	13.1	13.1	13.1	13.1	13.1	13.1	13.0	13.1
High Output (HO)								
Efficacy - Lumens per Watt	120	124	126	126	104	107	109	110
Lumens per foot (305mm)	3219	3321	3388	3388	2775	2863	2921	2950
Watts per foot (305mm)	27.0	27.0	27.0	27.0	27.0	27.0	27.0	27.0

Performance | Zipper Board Optics

Zipper Board Optics design has 72 diodes per foot (305mm).

Symmetric with EdgeGlow, up | 40° Symmetric, down (U2S1)

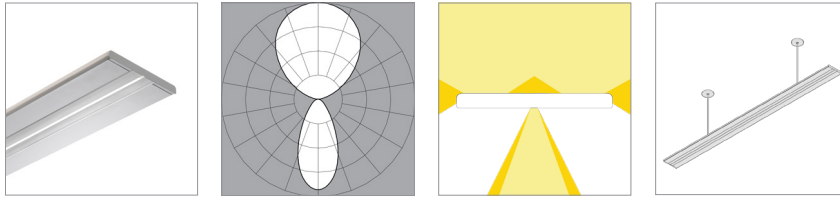

L80 >60,000 hours

	80 CRI (80min., 84 avg.)				90 CRI (90min., 96 avg.)			
	2700K	3000K	3500K	4000K	2700K	3000K	3500K	4000K
Low Output (LO)								
Efficacy - Lumens per Watt	94	97	99	99	81	83	85	88
Lumens per foot (305mm)	693	715	730	730	598	616	629	635
Watts per foot (305mm)	7.5	7.5	7.5	7.5	7.5	7.5	7.5	7.5

Standard Output (SO)								
Efficacy - Lumens per Watt	107	110	112	112	93	96	98	102
Lumens per foot (305mm)	1386	1430	1459	1459	1195	1233	1258	1271
Watts per foot (305mm)	13.1	13.1	13.1	13.1	13.0	13.0	13.0	13.0

High Output (HO)								
Efficacy - Lumens per Watt	98	101	104	104	85	88	89	93
Lumens per foot (305mm)	2634	2717	2773	2733	2271	2342	2390	2414
Watts per foot (305mm)	27.0	27.0	27.0	27.0	27.0	27.0	27.0	27.0

Symmetric with EdgeGlow, up | 60° Symmetric, down (U2S2)

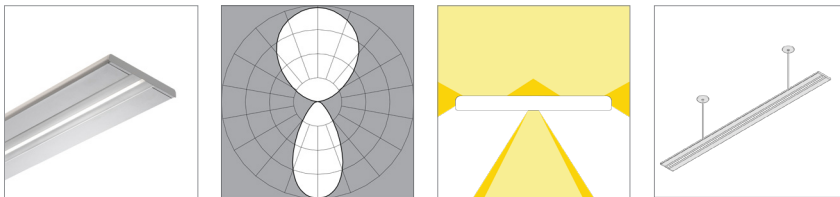

L80 >60,000 hours

	80 CRI (80min., 84 avg.)				90 CRI (90min., 96 avg.)			
	2700K	3000K	3500K	4000K	2700K	3000K	3500K	4000K
Low Output (LO)								
Efficacy - Lumens per Watt	107	110	112	112	92	95	97	101
Lumens per foot (305mm)	792	817	833	833	683	704	718	726
Watts per foot (305mm)	7.5	7.5	7.5	7.5	7.5	7.5	7.5	7.5

Standard Output (SO)								
Efficacy - Lumens per Watt	122	126	128	128	106	109	111	115
Lumens per foot (305mm)	1583	1633	1667	1667	1365	1408	1437	1451
Watts per foot (305mm)	13.1	13.1	13.1	13.1	13.0	13.0	13.0	13.0

High Output (HO)								
Efficacy - Lumens per Watt	112	116	118	118	97	100	102	106
Lumens per foot (305mm)	3009	3104	3167	3167	2594	2675	2730	2757
Watts per foot (305mm)	27.0	27.0	27.0	27.0	27.0	27.0	27.0	27.0

Performance | Zipper Board Optics

Zipper Board Optics design has 72 diodes per foot (305mm).

Symmetric with EdgeGlow, up | 80° Symmetric, down (U2S7)

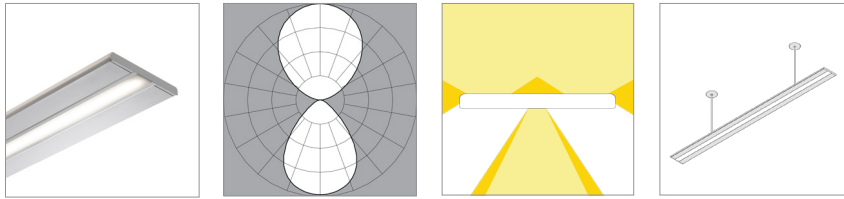

L80 >60,000 hours

	80 CRI (80min., 84 avg.)				90 CRI (90min., 96 avg.)			
	2700K	3000K	3500K	4000K	2700K	3000K	3500K	4000K
Low Output (LO)								
Efficacy - Lumens per Watt	114	117	120	120	98	101	103	107
Lumens per foot (305mm)	844	870	888	888	727	750	766	773
Watts per foot (305mm)	7.5	7.5	7.5	7.5	7.5	7.5	7.5	7.5

Standard Output (SO)								
Efficacy - Lumens per Watt	130	134	136	136	113	116	119	124
Lumens per foot (305mm)	1687	1741	1776	1776	1455	1501	1531	1546
Watts per foot (305mm)	13.1	13.1	13.1	13.1	13.0	13.0	13.0	13.0

High Output (HO)								
Efficacy - Lumens per Watt	120	123	126	126	103	106	109	113
Lumens per foot (305mm)	3206	3307	3375	3375	2764	2851	2909	2938
Watts per foot (305mm)	27.0	27.0	27.0	27.0	27.0	27.0	27.0	27.0

Symmetric with EdgeGlow, up | Soft Diffuse, down (U2D2)

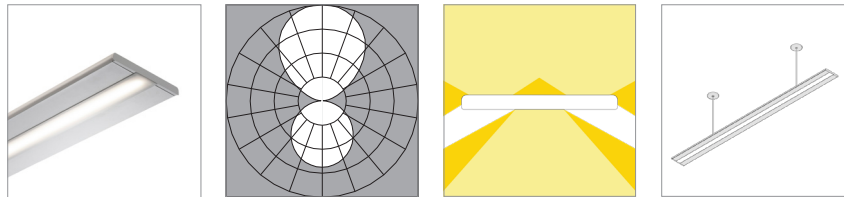

L80 >60,000 hours

	80 CRI (80min., 84 avg.)				90 CRI (90min., 96 avg.)			
	2700K	3000K	3500K	4000K	2700K	3000K	3500K	4000K
Low Output (LO)								
Efficacy - Lumens per Watt	120	124	126	126	103	107	109	110
Lumens per foot (305mm)	888	916	935	935	766	790	806	814
Watts per foot (305mm)	7.5	7.5	7.5	7.5	7.5	7.5	7.5	7.5

Standard Output (SO)								
Efficacy - Lumens per Watt	136	141	144	144	119	123	125	126
Lumens per foot (305mm)	1776	1832	1870	1870	1531	1579	1612	1628
Watts per foot (305mm)	13.1	13.1	13.1	13.1	13.0	13.0	13.0	13.0

High Output (HO)								
Efficacy - Lumens per Watt	126	130	132	132	109	112	114	115
Lumens per foot (305mm)	3375	3481	3552	3552	2909	3001	3062	3093
Watts per foot (305mm)	27.0	27.0	27.0	27.0	27.0	27.0	27.0	27.0

Performance | Zipper Board Optics

Zipper Board Optics design has 72 diodes per foot (305mm).

Symmetric, up | 40° Symmetric, down (U1S1-BL)

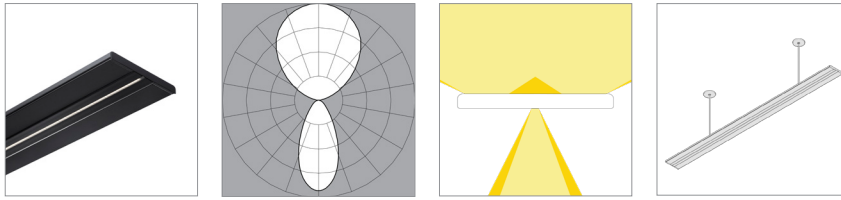

L80 >60,000 hours

	80 CRI (80min., 84 avg.)				90 CRI (90min., 96 avg.)			
	2700K	3000K	3500K	4000K	2700K	3000K	3500K	4000K
Low Output (LO)								
Efficacy - Lumens per Watt	78	80	82	82	67	69	70	73
Lumens per foot (305mm)	574	592	604	604	495	510	521	526
Watts per foot (305mm)	7.5	7.5	7.5	7.5	7.5	7.5	7.5	7.5
Standard Output (SO)								
Efficacy - Lumens per Watt	88	91	93	93	77	79	81	84
Lumens per foot (305mm)	1148	1184	1208	1208	989	1021	1041	1052
Watts per foot (305mm)	13.1	13.1	13.1	13.1	13.0	13.0	13.0	13.0
High Output (HO)								
Efficacy - Lumens per Watt	82	84	86	86	70	73	74	77
Lumens per foot (305mm)	2180	2249	2295	2295	1880	1939	1979	1998
Watts per foot (305mm)	27.0	27.0	27.0	27.0	27.0	27.0	27.0	27.0

Symmetric, up | 60° Symmetric, down (U1S2-BL)

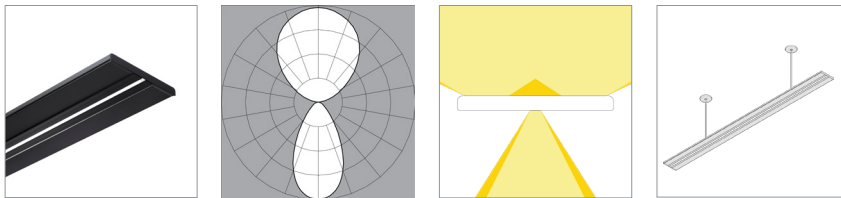

L80 >60,000 hours

	80 CRI (80min., 84 avg.)				90 CRI (90min., 96 avg.)			
	2700K	3000K	3500K	4000K	2700K	3000K	3500K	4000K
Low Output (LO)								
Efficacy - Lumens per Watt	90	93	95	95	78	80	82	82
Lumens per foot (305mm)	665	687	701	701	574	592	604	610
Watts per foot (305mm)	7.5	7.5	7.5	7.5	7.5	7.5	7.5	7.5
Standard Output (SO)								
Efficacy - Lumens per Watt	102	106	108	108	89	92	94	95
Lumens per foot (305mm)	1331	1373	1401	1401	1147	1184	1208	1220
Watts per foot (305mm)	13.1	13.1	13.1	13.1	13.0	13.0	13.0	13.0
High Output (HO)								
Efficacy - Lumens per Watt	94	97	99	99	81	84	86	87
Lumens per foot (305mm)	2529	2609	2662	2662	2180	2249	2295	2318
Watts per foot (305mm)	27.0	27.0	27.0	27.0	27.0	27.0	27.0	27.0

Performance | Zipper Board Optics

Zipper Board Optics design has 72 diodes per foot (305mm).

Symmetric, up | 80° Symmetric, down (U1S7-BL)

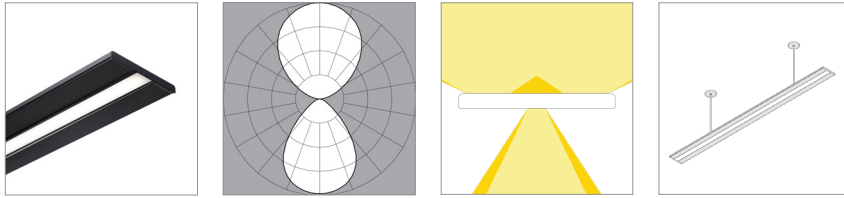

L80 >60,000 hours

Low Output (LO)	80 CRI (80min., 84 avg.)				90 CRI (90min., 96 avg.)			
	2700K	3000K	3500K	4000K	2700K	3000K	3500K	4000K
Efficacy - Lumens per Watt	101	104	106	106	87	90	92	96
Lumens per foot (305mm)	748	771	787	787	644	665	678	685
Watts per foot (305mm)	7.5	7.5	7.5	7.5	7.5	7.5	7.5	7.5

Standard Output (SO)	2700K	3000K	3500K	4000K	2700K	3000K	3500K	4000K
Efficacy - Lumens per Watt	115	119	121	121	99	102	104	108
Lumens per foot (305mm)	1495	1542	1574	1574	1289	1330	1357	1370
Watts per foot (305mm)	13.1	13.1	13.1	13.1	13.1	13.1	13.1	13.1

High Output (HO)	2700K	3000K	3500K	4000K	2700K	3000K	3500K	4000K
Efficacy - Lumens per Watt	106	109	112	112	91	94	96	100
Lumens per foot (305mm)	2841	2930	2990	2990	2449	2526	2578	2604
Watts per foot (305mm)	27.0	27.0	27.0	27.0	27.0	27.0	27.0	27.0

Symmetric, up | Soft Diffuse, down (U1D2-BL)

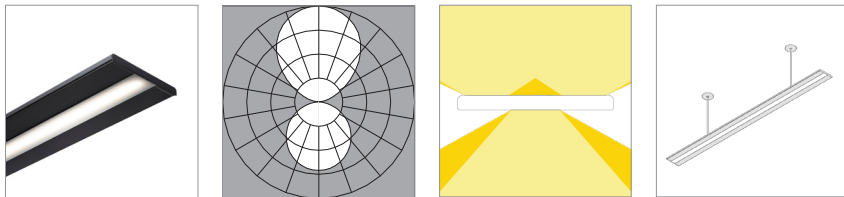

L80 >60,000 hours

Low Output (LO)	80 CRI (80min., 84 avg.)				90 CRI (90min., 96 avg.)			
	2700K	3000K	3500K	4000K	2700K	3000K	3500K	4000K
Efficacy - Lumens per Watt	107	110	112	112	92	95	97	98
Lumens per foot (305mm)	791	816	833	833	682	704	718	725
Watts per foot (305mm)	7.5	7.5	7.5	7.5	7.5	7.5	7.5	7.5

Standard Output (SO)	2700K	3000K	3500K	4000K	2700K	3000K	3500K	4000K
Efficacy - Lumens per Watt	122	126	128	128	105	108	111	112
Lumens per foot (305mm)	1583	1633	1666	1666	1364	1408	1436	1451
Watts per foot (305mm)	13.1	13.1	13.1	13.1	13.1	13.1	13.1	13.1

High Output (HO)	2700K	3000K	3500K	4000K	2700K	3000K	3500K	4000K
Efficacy - Lumens per Watt	112	116	118	118	97	100	102	103
Lumens per foot (305mm)	3007	3102	3165	3165	2592	2674	2729	2756
Watts per foot (305mm)	27.0	27.0	27.0	27.0	27.0	27.0	27.0	27.0

Performance | Zipper Board Optics

Zipper Board Optics design has 72 diodes per foot (305mm).

Symmetric with EdgeGlow, up | 40° Symmetric, down (U2S1-BL)

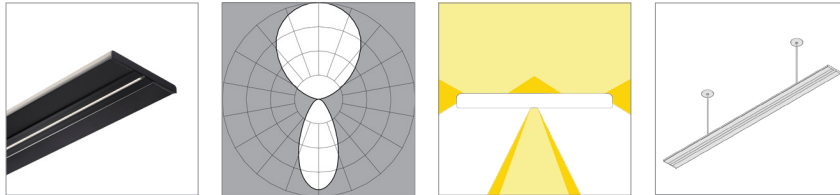

L80 >60,000 hours

	80 CRI (80min., 84 avg.)				90 CRI (90min., 96 avg.)			
	2700K	3000K	3500K	4000K	2700K	3000K	3500K	4000K
Low Output (LO)								
Efficacy - Lumens per Watt	84	86	88	88	72	74	76	79
Lumens per foot (305mm)	618	638	651	651	533	550	561	567
Watts per foot (305mm)	7.5	7.5	7.5	7.5	7.5	7.5	7.5	7.5
Standard Output (SO)								
Efficacy - Lumens per Watt	95	98	100	100	82	85	87	90
Lumens per foot (305mm)	1237	1276	1302	1302	1066	1100	1122	1133
Watts per foot (305mm)	13.1	13.1	13.1	13.1	13.1	13.1	13.0	13.1
High Output (HO)								
Efficacy - Lumens per Watt	88	91	92	92	76	78	80	83
Lumens per foot (305mm)	2349	2424	2473	2473	2025	2089	2132	2153
Watts per foot (305mm)	27.0	27.0	27.0	27.0	27.0	27.0	27.0	27.0

Symmetric with EdgeGlow, up | 60° Symmetric, down (U2S2-BL)

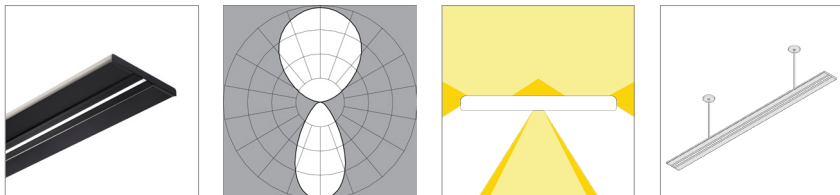

L80 >60,000 hours

	80 CRI (80min., 84 avg.)				90 CRI (90min., 96 avg.)			
	2700K	3000K	3500K	4000K	2700K	3000K	3500K	4000K
Low Output (LO)								
Efficacy - Lumens per Watt	95	98	100	100	82	84	86	89
Lumens per foot (305mm)	702	724	739	739	605	624	637	643
Watts per foot (305mm)	7.5	7.5	7.5	7.5	7.5	7.5	7.5	7.5
Standard Output (SO)								
Efficacy - Lumens per Watt	108	111	114	114	94	97	99	103
Lumens per foot (305mm)	1403	1448	1477	1477	1210	1248	1274	1286
Watts per foot (305mm)	13.1	13.1	13.1	13.1	13.0	13.0	13.0	13.0
High Output (HO)								
Efficacy - Lumens per Watt	100	103	105	105	86	89	90	94
Lumens per foot (305mm)	2667	2751	2807	2807	2299	2371	2420	2444
Watts per foot (305mm)	27.0	27.0	27.0	27.0	27.0	27.0	27.0	27.0

Performance | Zipper Board Optics

Zipper Board Optics design has 72 diodes per foot (305mm).

Symmetric with EdgeGlow, up | 80° Symmetric, down (U2S7-BL)

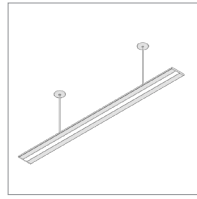
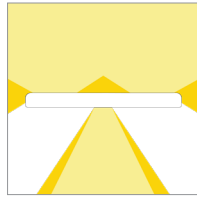
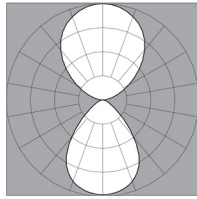
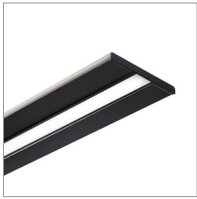

L80 >60,000 hours

	2700K	80 CRI (80min., 84 avg.)				90 CRI (90min., 96 avg.)			
		3000K	3500K	4000K	2700K	3000K	3500K	4000K	
Low Output (LO)									
Efficacy - Lumens per Watt	105	108	110	110	90	93	95	99	
Lumens per foot (305mm)	775	800	816	816	668	689	703	710	
Watts per foot (305mm)	7.5	7.5	7.5	7.5	7.5	7.5	7.5	7.5	

	2700K	80 CRI (80min., 84 avg.)				90 CRI (90min., 96 avg.)			
		3000K	3500K	4000K	2700K	3000K	3500K	4000K	
Standard Output (SO)									
Efficacy - Lumens per Watt	119	123	125	125	103	106	108	112	
Lumens per foot (305mm)	1550	1599	1632	1632	1336	1379	1407	1421	
Watts per foot (305mm)	13.1	13.1	13.1	13.1	13.1	13.1	13.1	13.1	

	2700K	80 CRI (80min., 84 avg.)				90 CRI (90min., 96 avg.)			
		3000K	3500K	4000K	2700K	3000K	3500K	4000K	
High Output (HO)									
Efficacy - Lumens per Watt	110	113	116	116	95	98	100	104	
Lumens per foot (305mm)	2945	3038	3100	3100	2539	2619	2673	2699	
Watts per foot (305mm)	27.0	27.0	27.0	27.0	27.0	27.0	27.0	27.0	

Symmetric with EdgeGlow, up | Soft Diffuse, down (U2D2-BL)

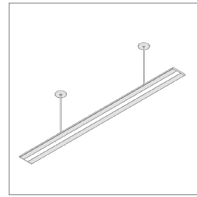
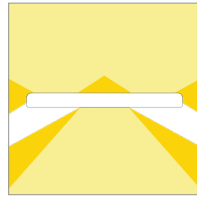
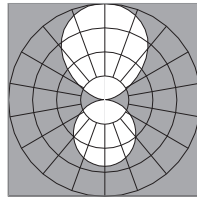
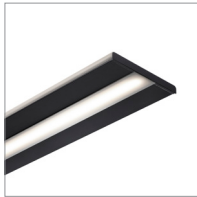

L80 >60,000 hours

	2700K	80 CRI (80min., 84 avg.)				90 CRI (90min., 96 avg.)			
		3000K	3500K	4000K	2700K	3000K	3500K	4000K	
Low Output (LO)									
Efficacy - Lumens per Watt	111	115	117	117	96	99	101	102	
Lumens per foot (305mm)	476	491	501	501	410	423	432	436	
Watts per foot (305mm)	7.5	7.5	7.5	7.5	7.5	7.5	7.5	7.5	

	2700K	80 CRI (80min., 84 avg.)				90 CRI (90min., 96 avg.)			
		3000K	3500K	4000K	2700K	3000K	3500K	4000K	
Standard Output (SO)									
Efficacy - Lumens per Watt	127	131	134	134	110	113	115	116	
Lumens per foot (305mm)	952	982	1002	1002	821	847	864	873	
Watts per foot (305mm)	13.1	13.1	13.1	13.1	13.1	13.1	13.1	13.1	

	2700K	80 CRI (80min., 84 avg.)				90 CRI (90min., 96 avg.)			
		3000K	3500K	4000K	2700K	3000K	3500K	4000K	
High Output (HO)									
Efficacy - Lumens per Watt	117	121	123	123	101	104	106	107	
Lumens per foot (305mm)	1809	1866	1904	1904	1559	1609	1641	1658	
Watts per foot (305mm)	27.0	27.0	27.0	27.0	27.0	27.0	27.0	27.0	

Copyright © 2022 Vode Lighting LLC. All rights reserved. Vode, the Vode logo, BoxRail, FlyWing, MicroBaffle, Button Board, Zipper Board, Zero Canopy, Zero Block, VodeNODE and other names are either registered trademarks or trademarks of Vode Lighting LLC in the United States and may be registered in other countries. All other trademarks listed herein belong to their respective owners. Due to ongoing innovation, specification details may change without notice.