



Spec Guide

RaceRail | Stack | 117

Red List
Approved

Declare.

Direct lighting for library stack and display applications.



RaceRail, direct or indirect, 370° rotation.

Benefits & Features

Minimal, Robust Design

Round profile, Ø1.12" (28mm), 370° rotation. Round profile, Ø1.12" (28mm), 370° rotation.

Superior Light Quality & Performance

Output up to 1507 lm/ft (4943 lm/m) (HO), 132 lm/W (SO). 80 or 90 CRI & tunable white (2200K-6500K) available.

Adaptable Power Modules

Integral Power, full range dimming power for all protocols.

Better Optics & Beam Control Options

FlyWing™ and diffuse lens available. Directional control with 370° rotation, angle gauge and lock.

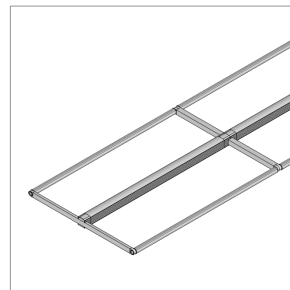

Double-sided



Single-sided

Build Your Specification

117-RR				ST	18 >>
---------------	--	--	--	-----------	--------------

System & Rail Type	Single/Double Rail	System Length	Rail Length	Mounting	Arm Length
117-RR RaceRail	K1 Single-sided K2 Double-sided	Specify overall system length in ft/in or M/mm.	24 24" (610mm) 36 36" (914mm) 48 48" (1219mm) 60 60" (1524mm) 72 72" (1829mm) ZZ Other rail length or layout (please specify)	ST Stack	18 18" arm (457mm) ZZ Other (please specify)
See Rail Length Chart for more details.					
⚠ Custom lengths may result in light gaps on the fixture. See Rail Length Chart for more details.					

>> IP				Z >>
--------------	--	--	--	-------------

Power Location	Power Type	Voltage	Emergency Power	LED Type
Integral Power IP Integral Power	AE 0-10V, 1.0% Dimming AT 0-10V, 0.1% Dimming AD DALI, 0.1% Dimming AX DMX, 100-0% Dimming AH Hi-lume 1% EcoSystem, Soft On / Fade to Black Technology, LDE ¹ AH2 ELV 1% 2-wire (Forward and Reverse Phase)	1 120v 2 120V - 277V X Not Yet Specified	0 No Emergency Power ZZ Emergency Power (specify requirements)	Z Zipper Board
See Power Guide for driver features & limitations.				

>>				
----	--	--	--	--

Lumen Output	Color Temperature	Optics	Finish	Options
LO Low Output SO Standard Output HO High Output ZZ Other (please specify) See IES Files page for details. See Power Guide for driver features & limitations.	80+ CRI 27 2700K 30 3000K 35 3500K 40 4000K 90+ CRI 279 2700K 309 3000K 359 3500K 409 4000K ZZ Other (please specify)	Zipper Board (Z) 2 Diffuse, round G1 120° Batwing G2 120° FlyWing	AL Clear Anodized WH White Painted BL Black Anodized ZZ Other (please specify)	0 None ZZ Other (please specify)

Standard 5 Year Limited Warranty. See details [here](#). Contact factory for options on Limited Warranties up to 20 years.

Listed to UL standards for damp location by a Nationally Recognized Testing Laboratory (NRTL) recognized by OSHA.



Applications

Library Stack and Display

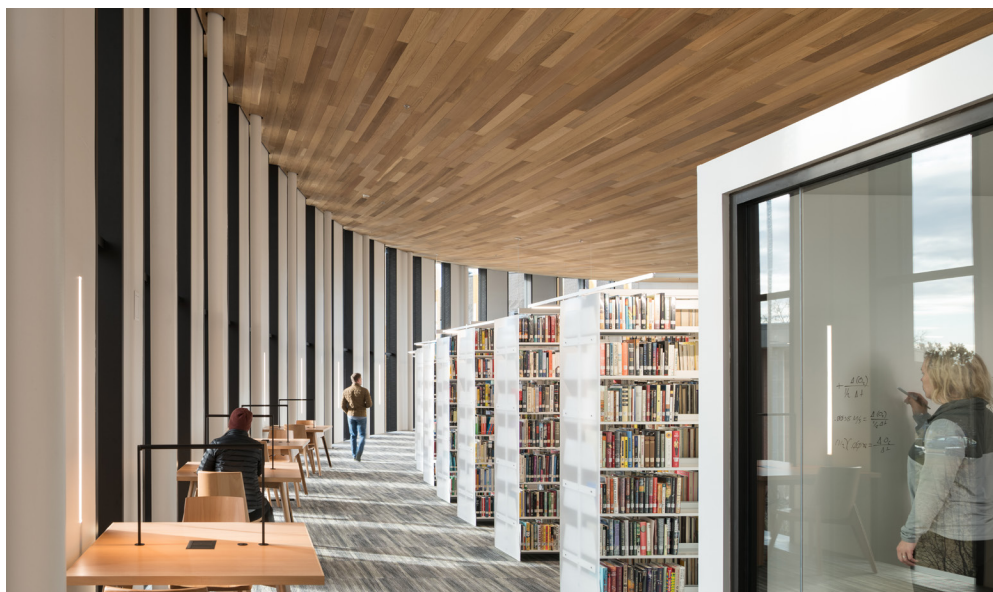
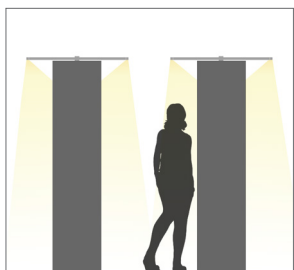

Cruzen-Murray Academic Library, Caldwell, ID

Structure

Rail Lengths	24" (610mm), 36" (914mm), 48" (1219mm), 60" (1524mm), 72" (1829mm).
Rail Dimensions	Ø1.12" (28mm).
Construction	Extruded and machined 6063 aluminum.
Mounting	Single or double-sided stack mount to integral power housing.
Arm Length	18" (457mm). Standard and non-standard lengths available. Single-sided requires lengths 24" or less.
System Run Length	24" (610mm) minimum. Unlimited maximum.
Operating Temperature	32°F to 104°F (0°C to 40°C).
Humidity	0-85%, non-condensing.

Materials

LED Board Construction	Aluminum core PCB, black LCP connectors, RoHS compliant.
Lens	High-impact extruded acrylic glass (PMMA).
Power Cable	Ø4mm, 18/2 AWG, Plenum (CMP) rated semi-rigid PVC or FEP, flame tested UL-910 (<i>PVC free in 2020</i>)
Cable Connectors	Unfilled black nylon, rated UL 94 V-0, halogen free, PVC or FEP overmold, RoHS compliant (<i>PVC free in 2020</i>)
Integral Power Housing	Extruded and machined 6063 aluminum.

Declare Label

All Vode Lighting linear light fixtures proudly carry the Red List Approved designation.

See [International Living Future Institute](https://www.living-future.org) website for details.



Vode Adaptive Architectural Lighting Systems
Vode Lighting LLC

Final Assembly: Sonoma, California, US
Life Expectancy: 10+ Year(s)
End of Life Options: Recyclable (100%)

Ingredients:

Anodized Aluminum (6063-T5 Alloy); Steel; Small Electrical Component (RoHS)¹; Copper; **Fluorinated Ethylene Propylene (masterbatch)**²; Polymethyl methacrylate (PMMA); Stainless Steel; Polyoxymethylene Copolymer (POM); Styrene-butadiene polymer, hydrogenated; Poly(methyl methacrylate/butyl acrylate/styrene) (PMMA/BA/S); Styrene/butadiene copolymer; Distillates; Polypropylene; Calcium carbonate; Polycarbonate; EVA Copolymer; Methyl methacrylate (MMA); Polyphenylene Oxide; Brass; Tin, Organic

¹LBC Temp Exception RL-002 - Small Electrical Components
²LBC Temp Exception RL-023 - Wire Sheathing Subject to NFPA 90A, NFPA 262, UL® 910

Living Building Challenge Criteria: Compliant

I-13 Red List:

<input type="checkbox"/> LBC Red List Free	% Disclosed: 100% at 100ppm
<input checked="" type="checkbox"/> LBC Red List Approved	VOC Content: Not Applicable
<input type="checkbox"/> Declared	

I-10 Interior Performance: Not Applicable
I-14 Responsible Sourcing: Not Applicable

VDE-0001
 EXP. 01 JAN 2025
 Original Issue Date: 2018

MANUFACTURER RESPONSIBLE FOR LABEL ACCURACY
 INTERNATIONAL LIVING FUTURE INSTITUTE™ [living-future.org/declare](https://www.living-future.org/declare)



Dimensions

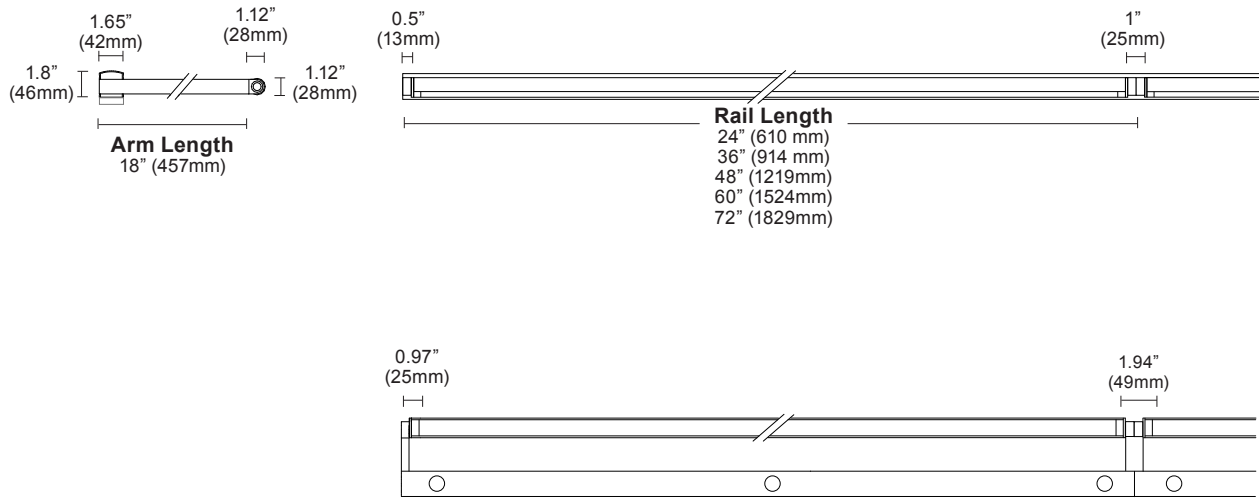

Layout

Single Sided (K1)

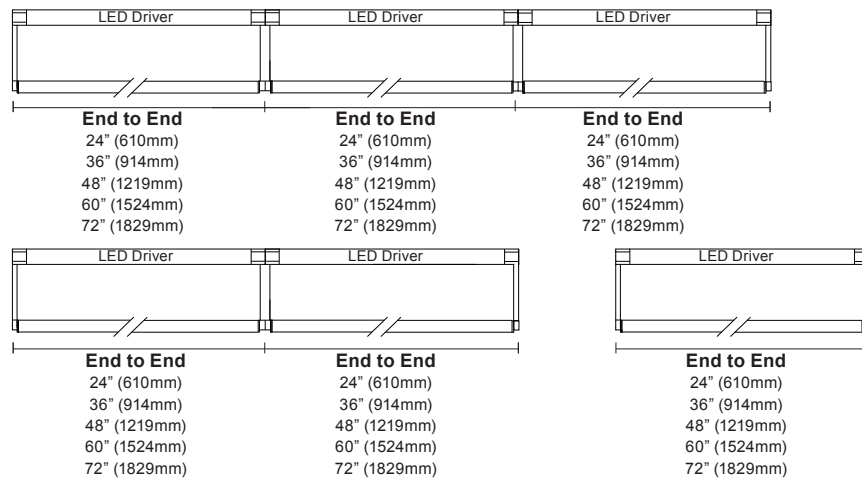

Double Sided (K2)

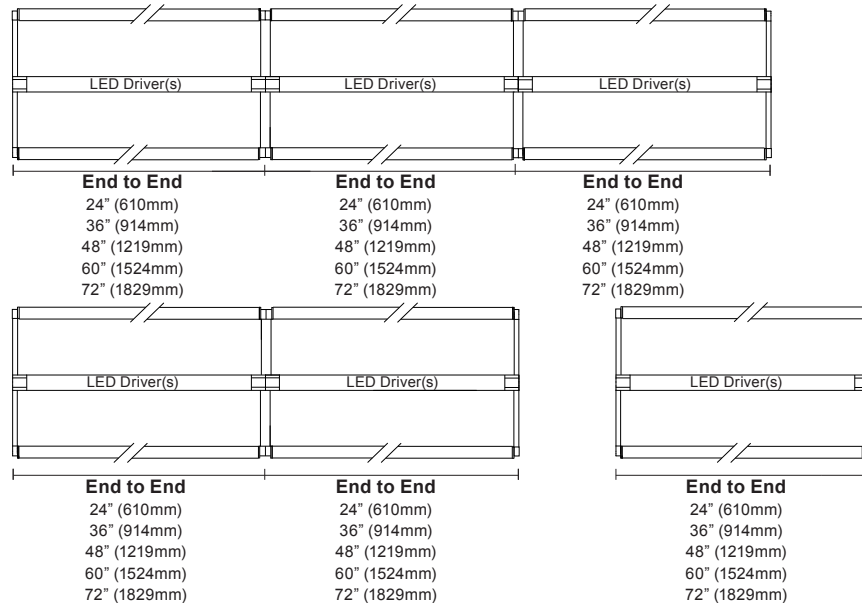

Mounting Options

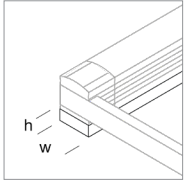

Vode Strut
 (provided with systems
 with multiple rail sections)
 h 0.8" (20mm)
 w 1.61" (41mm)

Power and Controls

Power Type	Class 2 (<60V output) constant current driver.
Dimming Controls	Dimming (0.1%, 1%), 0-10V, DALI, DMX, Lutron Hi-lume 1% are available. See Power Guide for details.
Input Voltage	120V - 277V, 50/60hz.
Power Location	Integral power. See Power Guide for details.

Performance | Zipper Board Optics

Zipper Board Optics design has 72 diodes per foot (305mm).

Diffuse, round (2)

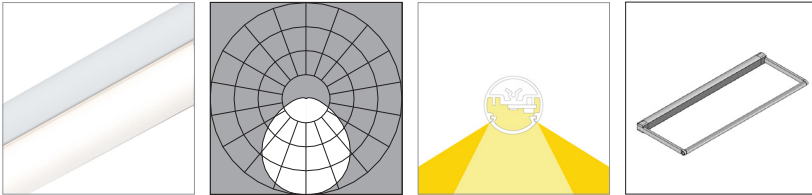

L80 >60,000 hours

	80 CRI (80min., 84 avg.)				90 CRI (90min., 96 avg.)			
	2700K	3000K	3500K	4000K	2700K	3000K	3500K	4000K
Low Output (LO)								
Efficacy - Lumens per Watt	99	102	105	107	86	88	90	92
Lumens per foot (305mm)	369	381	389	396	318	328	335	342
Watts per foot (305mm)	3.8	3.8	3.8	3.8	3.8	3.8	3.8	3.8
Standard Output (SO)								
Efficacy - Lumens per Watt	123	127	129	132	106	109	112	114
Lumens per foot (305mm)	739	762	777	793	637	657	670	684
Watts per foot (305mm)	6.1	6.1	6.1	6.1	6.1	6.1	6.1	6.1
High Output (HO)								
Efficacy - Lumens per Watt	115	118	121	123	99	102	104	106
Lumens per foot (305mm)	1403	1448	1477	1507	1210	1248	1273	1299
Watts per foot (305mm)	12.4	12.4	12.4	12.4	12.4	12.4	12.4	12.4

Performance | Zipper Board Optics

Zipper Board Optics design has 72 diodes per foot (305mm).

120° Batwing (G1)

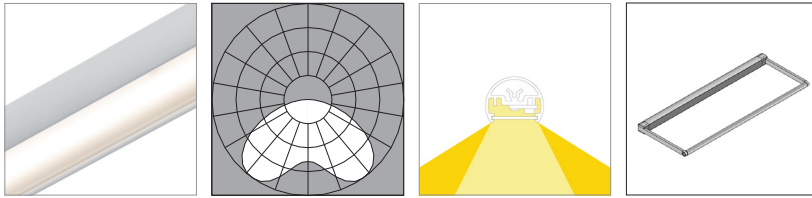

L80 >60,000 hours

	80 CRI (80min., 84 avg.)				90 CRI (90min., 96 avg.)			
	2700K	3000K	3500K	4000K	2700K	3000K	3500K	4000K
Low Output (LO)								
Efficacy - Lumens per Watt	88	91	93	95	76	79	80	82
Lumens per foot (305mm)	328	339	346	353	283	292	298	304
Watts per foot (305mm)	3.8	3.8	3.8	3.8	3.8	3.8	3.8	3.8

Standard Output (SO)

Efficacy - Lumens per Watt	110	113	115	118	95	98	100	102
Lumens per foot (305mm)	657	677	691	705	566	584	596	608
Watts per foot (305mm)	6.1	6.1	6.1	6.1	6.1	6.1	6.1	6.1

High Output (HO)

Efficacy - Lumens per Watt	102	105	107	109	88	91	93	94
Lumens per foot (305mm)	1248	1287	1313	1340	1076	1110	1132	1155
Watts per foot (305mm)	12.4	12.4	12.4	12.4	12.4	12.4	12.4	12.4

120° FlyWing (G2)

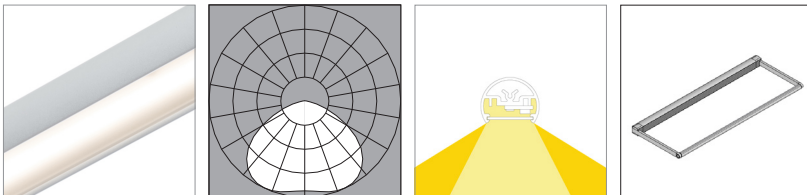

L80 is >60,000 hours

	80 CRI (80min., 84 avg.)				90 CRI (90min., 96 avg.)			
	2700K	3000K	3500K	4000K	2700K	3000K	3500K	4000K
Low Output (LO)								
Efficacy - Lumens per Watt	86	89	91	93	74	77	78	80
Lumens per foot (305mm)	320	331	33	344	276	285	291	297
Watts per foot (305mm)	3.8	3.8	3.8	3.8	3.8	3.8	3.8	3.8

Standard Output (SO)

Efficacy - Lumens per Watt	107	110	113	115	92	95	97	99
Lumens per foot (305mm)	641	661	675	688	552	570	582	593
Watts per foot (305mm)	6.1	6.1	6.1	6.41	6.1	6.1	6.1	6.1

High Output (HO)

Efficacy - Lumens per Watt	99	103	105	107	86	89	90	92
Lumens per foot (305mm)	1218	1256	1282	1307	1050	1083	1105	1127
Watts per foot (305mm)	12.4	12.4	12.4	12.4	12.4	12.4	12.4	12.4

Copyright © 2022 Vode Lighting LLC. All rights reserved. Vode, the Vode logo, BoxRail, FlyWing, MicroBaffle, Button Board, Zipper Board, Zero Canopy, Zero Block, VodeNODE and other names are either registered trademarks or trademarks of Vode Lighting LLC in the United States and may be registered in other countries. All other trademarks listed herein belong to their respective owners. Due to ongoing innovation, specification details may change without notice.