



Spec Guide

# BoxRail | Ceiling Cable | 107



Direct or indirect lighting for open office and ambient applications.

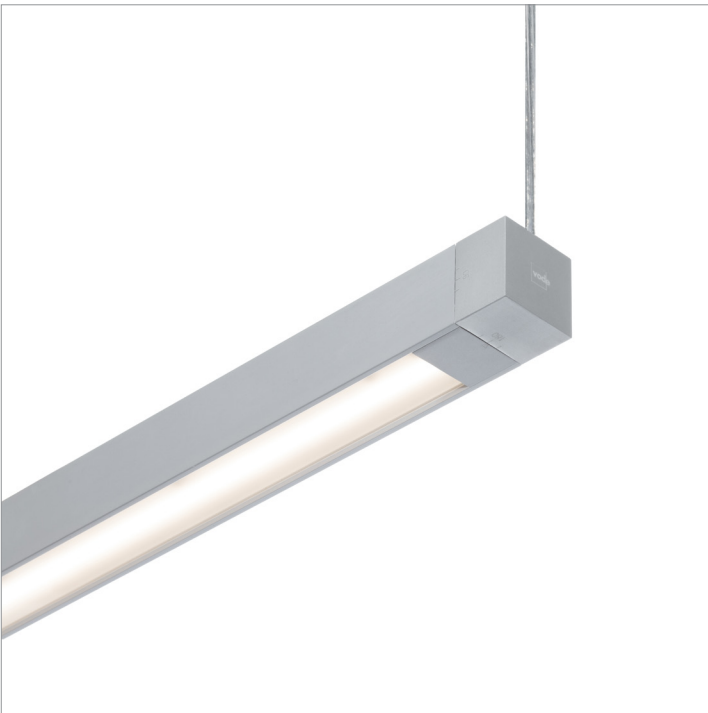

BoxRail: direct or indirect, infinite rotation

## Benefits & Features

### Minimal Profile, Robust Design

Square profile, 1.14" (29mm) x 1.14" (29mm).

### Superior Light Quality & Performance

Output up to 1484 lm/ft (4869 lm/m) (HO), 131 lm/W (SO). 80 or 90 CRI & tunable white (2200K-5000K) available.

### Adaptive Power

Full range dimming power for all protocols. Integral or remote power available.

### Better Optics & Beam Control Options

Batwing, FlyWing, MicroBaffle, diffuse lens and narrow optics available. Directional control with infinite rotation, angle gauge and lock.

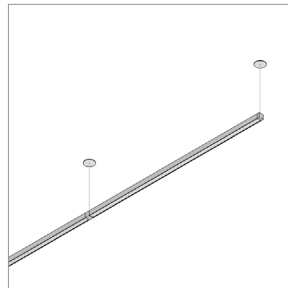

Large Round Canopy, Remote Power

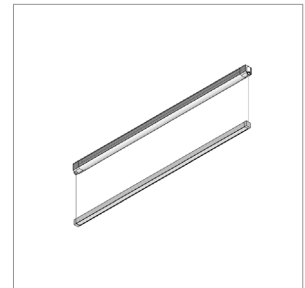

Integral Power

## Build Your Specification

<b>107-BX</b>	<b>01</b>			<b>CC</b>	»
<b>System &amp; Rail Type</b>	<b>Single/Double Rail</b>	<b>System Length</b>	<b>Rail Length</b>	<b>Mounting</b>	<b>Cable Length</b>
107-BX BoxRail	01 Single Rail	Specify overall system length in ft/in or M/mm.  <i>Corner and Shapes Available</i> <b>See Guide</b> for details.	<b>24</b> 24" (610mm) <b>36</b> 36" (914mm) <b>48</b> 48" (1219mm) <b>60</b> 60" (1524mm) <b>72</b> 72" (1829mm) <b>ZZ</b> Other rail length or layout (please specify)  See <b>Rail Length Chart</b> for more details.  <b>▲ Custom lengths may result in light gaps on the fixture. See Rail Length Chart for more details.</b>	CC Ceiling Cable	<i>Field adjustable.</i>  <b>48</b> 48" cable (1219mm) <b>96</b> 96" cable (2438mm) <b>ZZ</b> Other (please specify)

					»
<b>Power Location</b>		<b>Power Type</b>	<b>Voltage</b>	<b>Emergency Power</b>	
<b>Integral Power</b>		<b>Flexible 1 to 1 Power</b>	<b>1</b> 120V	<b>0</b> No Emergency Power	
<b>IP</b> Integral Power		<b>AE</b> 0-10v, 1.0% Dimming	<b>2</b> 120V - 277V	<b>ZZ</b> Emergency Power	(specify requirements)
<b>Remote Power</b>		<b>AT</b> 0-10v, 0.1% Dimming	<b>X</b> Not Yet Specified		
Specify mounting and harness length code example: <b>2R25, 4R25</b> ...etc.		<b>AD</b> DALI, 0.1% Dimming			
<b>Mounting Option</b>	<b>Wire Harness</b>	<b>AX</b> DMX, 100-0% Dimming			
<b>2R</b> Small Round Canopy	<b>10</b> 10' (3.048m) Wire Harness	<b>AH</b> Hi-lume 1% EcoSystem, Soft On / Fade to Black Technology, LDE <sup>1</sup>			
<b>4R</b> Large Round Canopy	<b>25</b> 25' (7.62m) Wire Harness	<b>AH2</b> ELV 1% 2-wire (Forward and Reverse Phase)			
	<b>50</b> 50' (15.24m) Wire Harness				
	<b>75</b> 75' (22.86m) Wire Harness	<b>Optimized Power</b>			
	<b>100</b> 100' (30.48m) Wire Harness	Add 'O' to power type example: AEO, ATO...etc. <sup>1</sup>			
		<b>VodeNODE</b>			
		Add 'N' to power type for Flexible 1 to 1 Power			
		Add 'ON' to power type for Optimized Power example: AEN, ATN, AEON, ADON...etc. <sup>2</sup>			
		<b>ZZ</b> Other (please specify)			
		See <b>Power Guide</b> for driver features & limitations.			

» <b>Z</b>					
<b>LED Type</b>	<b>Lumen Output</b>	<b>Color Temperature</b>	<b>Optics</b>	<b>Sensors <sup>6</sup></b>	
<b>Z</b> Zipper Board	<b>LO</b> Low Output	<b>80+ CRI</b>	<b>Zipper Board (Z)</b>	<b>0</b> None	
	<b>SO</b> Standard Output	<b>27</b> 2700K	<b>1</b> Diffuse	<b>ENC</b> Canopy with integrated Enlighted Micro Sensor <sup>5</sup>	
	<b>HO</b> High Output	<b>30</b> 3000K	<b>WB</b> White Baffle	<b>WSC</b> Canopy with integrated Legrand Wattstopper sensor <sup>5</sup>	
	<b>ZZ</b> Other (please specify)	<b>35</b> 3500K	<b>BB</b> Black Baffle	<b>LAC</b> Canopy with integrated Lutron Athena sensor <sup>5</sup>	
	See <b>IES Files</b> page for details.	<b>40</b> 4000K	<b>G1</b> 120° Batwing	<b>ZZ</b> Other (please specify)	
	See <b>Power Guide</b> for driver features & limitations.	<b>90+ CRI</b>	<b>G2</b> 120° FlyWing		
		<b>279</b> 2700K	<b>S1</b> 40° Symmetric		
		<b>309</b> 3000K	<b>S2</b> 60° Symmetric		
		<b>359</b> 3500K	<b>A1</b> 85° Asymmetric		
		<b>409</b> 4000K			
		<b>ZZ</b> Tunable White Available			
		See <b>Guide</b> for details.			

»	
<b>Finish</b>	<b>Options</b>
<b>AL</b> Clear Anodized	<b>0</b> None
<b>WH</b> White Powder Coat	<b>9</b> 9' 18/3 Cord and Plug
<b>BL</b> Black Anodized	<b>CP</b> Chicago Plenum
<b>ZZ</b> Other (please specify)	<b>LLLC</b> Luminaire Level Lighting Controls

**NOTES & LIMITATIONS**

- <sup>1</sup> Optimized Power is not available with Hi-lume 1% EcoSystem (AHO) Power Type.
  - <sup>2</sup> VodeNODE enclosure is not available with ELV 1% 2-wire (AH2) Power Type.
  - <sup>3</sup> 9' 18/3 Cord and Plug only available with Remote Power (RP).
  - <sup>4</sup> Chicago Plenum not applicable for wall arm mounting.
  - <sup>5</sup> Rotating fixture as an uplight will interfere with sensor operation.
  - <sup>6</sup> Sensors, drivers, and control units that are integrated into Vode fixtures are discrete components that communicate with network lighting controls. For more information about each network lighting control system, visit the manufacturer's website for additional system information and technical data sheets.
- For general information about network lighting controls, consult the DesignLights Consortium® (DLC) [Networked Lighting Control Qualified Product List](#)

Standard 5 Year Limited Warranty. See details [here](#). Contact factory for options on Limited Warranties up to 20 years.

Listed to UL standards for damp location by a Nationally Recognized Testing Laboratory (NRTL) recognized by OSHA. Certain limitations exist for each Certification. Contact factory for verification.



## Applications

### General Interior, Open Office



Microsoft's Mid-Market Offices, San Francisco, CA

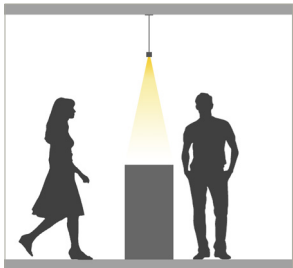

Rapt Studio, San Francisco, CA

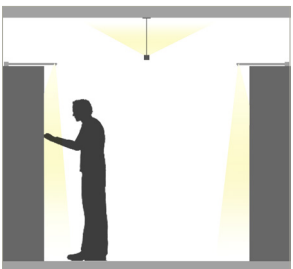

Libbie Mill Library, Richmond, VA

## Applications

### General Interior, Open Office



Sheppard Mullin, San Francisco, CA



Harold C. Smith Learning Commons, Springfield, MA

## Declare Label

All Vode Lighting linear light fixtures proudly carry the Red List Approved designation.

See [International Living Future Institute](https://www.livingfuture.org/declare) website for details.

# Declare.



## Vode Adaptive Architectural Lighting Systems Vode Lighting LLC

**Final Assembly:** Sonoma, California, US

**Life Expectancy:** 10+ Year(s)

**End of Life Options:** Recyclable (100%)

### Ingredients:

Anodized Aluminum (6063-T5 Alloy); Steel; Small Electrical Component (RoHS)<sup>1</sup>; Copper; **Fluorinated Ethylene Propylene (masterbatch)**<sup>2</sup>; Polymethyl methacrylate (PMMA); Stainless Steel; Polyoxymethylene Copolymer (POM); Styrene-butadiene polymer, hydrogenated; Poly(methyl methacrylate/butyl acrylate/styrene) (PMMA/BA/S); Styrene/butadiene copolymer; Distillates; Polypropylene; Calcium carbonate; Polycarbonate; EVA Copolymer; Methyl methacrylate (MMA); Polyphenylene Oxide; Brass; Tin, Organic

<sup>1</sup>LBC Temp Exception RL-002 - Small Electrical Components

<sup>2</sup>LBC Temp Exception RL-023 - Wire Sheathing Subject to NFPA 90A, NFPA 262, UL<sup>®</sup> 910

**Living Building Challenge Criteria:** Compliant

### I-13 Red List:

- |   |                             |
|---|-----------------------------|
| <input type="checkbox"/> LBC Red List Free                | % Disclosed: 100% at 100ppm |
| <input checked="" type="checkbox"/> LBC Red List Approved | VOC Content: Not Applicable |
| <input type="checkbox"/> Declared                         |                             |

**I-10 Interior Performance:** Not Applicable

**I-14 Responsible Sourcing:** Not Applicable

VDE-0001

EXP. 01 JAN 2025

Original Issue Date: 2018

MANUFACTURER RESPONSIBLE FOR LABEL ACCURACY  
INTERNATIONAL LIVING FUTURE INSTITUTE™ [living-future.org/declare](https://www.living-future.org/declare)

## Structure

Rail Lengths	24" (610mm) - 72" (1829mm). Modified lengths available. See <a href="#">Rail Length Chart</a> for more details.
Rail Dimensions	1.14" (29mm) x 1.14" (29mm) x length.
Construction	Extruded and machined 6063 aluminum.
Mounting	Ceiling mount to jbox or driver housing.
Cable Length	48" (1220mm) and 96" (2438mm) available. Field adjustable. Non-standard cable lengths available.
System Run Length	24" (610mm) minimum. Unlimited maximum.
Operating Temperature	32°F to 104°F (0°C to 40°C).
Humidity	0-85%, non-condensing.
System Weight	0.99 lbs per ft (0.45kg per 305mm) Power supply and housing not included.

## Materials

LED Board Construction	Aluminum core PCB, black LCP connectors, RoHS compliant.
Lens	High-impact extruded acrylic glass (PMMA).
Baffle	6063 aluminum, RoHS compliant painted finish.
Suspension Cable	Ø3.3mm, 22/2 AWG, PVC or TPE and RoHS compliant, Red List Approved.
Power Cable	Ø4mm, 18/2 AWG, Plenum (CMP) rated semi-rigid PVC or FEP, flame tested UL-910, Red List Approved.
Cable Connectors	Unfilled black nylon, rated UL 94 V-0, halogen free, PVC or FEP overmold, RoHS compliant, Red List Approved.
Remote Linear Power Housing (RLP)	20.7" x 2.375" x 2.53", 0.054" formed Galvanized Steel.
Remote Brick Power Housing (RBP)	4.32" x 3.37" x .078" Galvanized Steel mounting plate.

## Dimensions

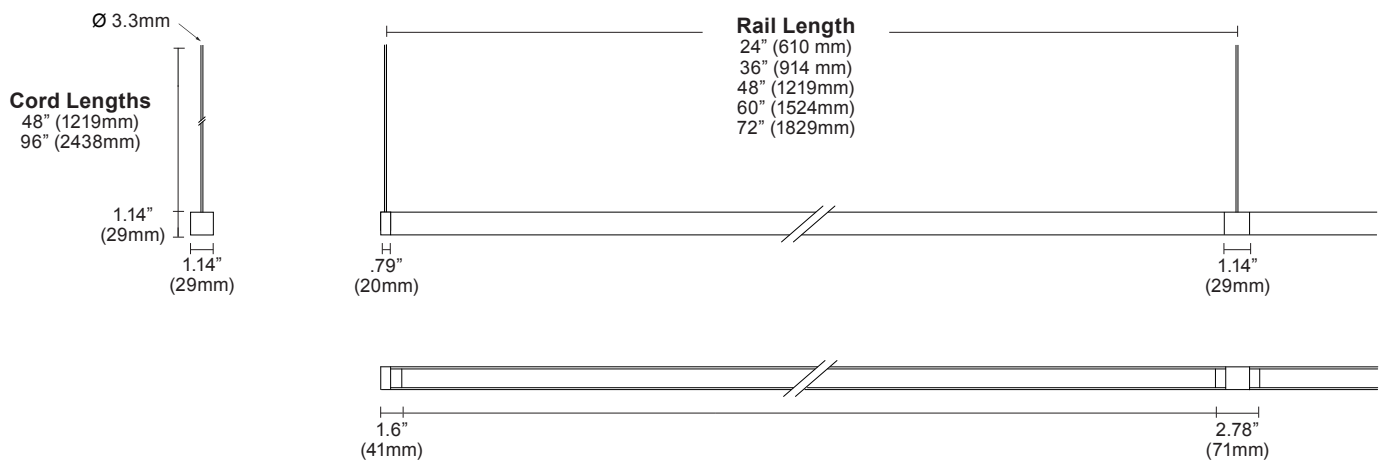

## Mounting Options

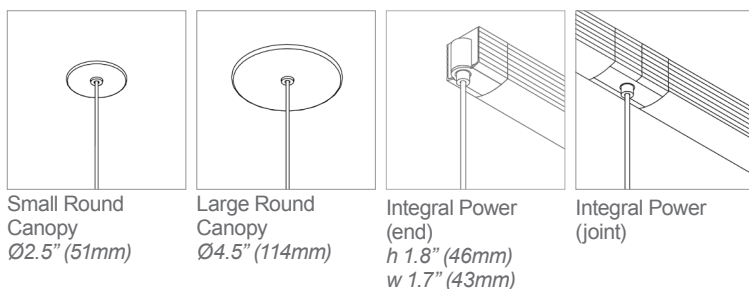

## Layout

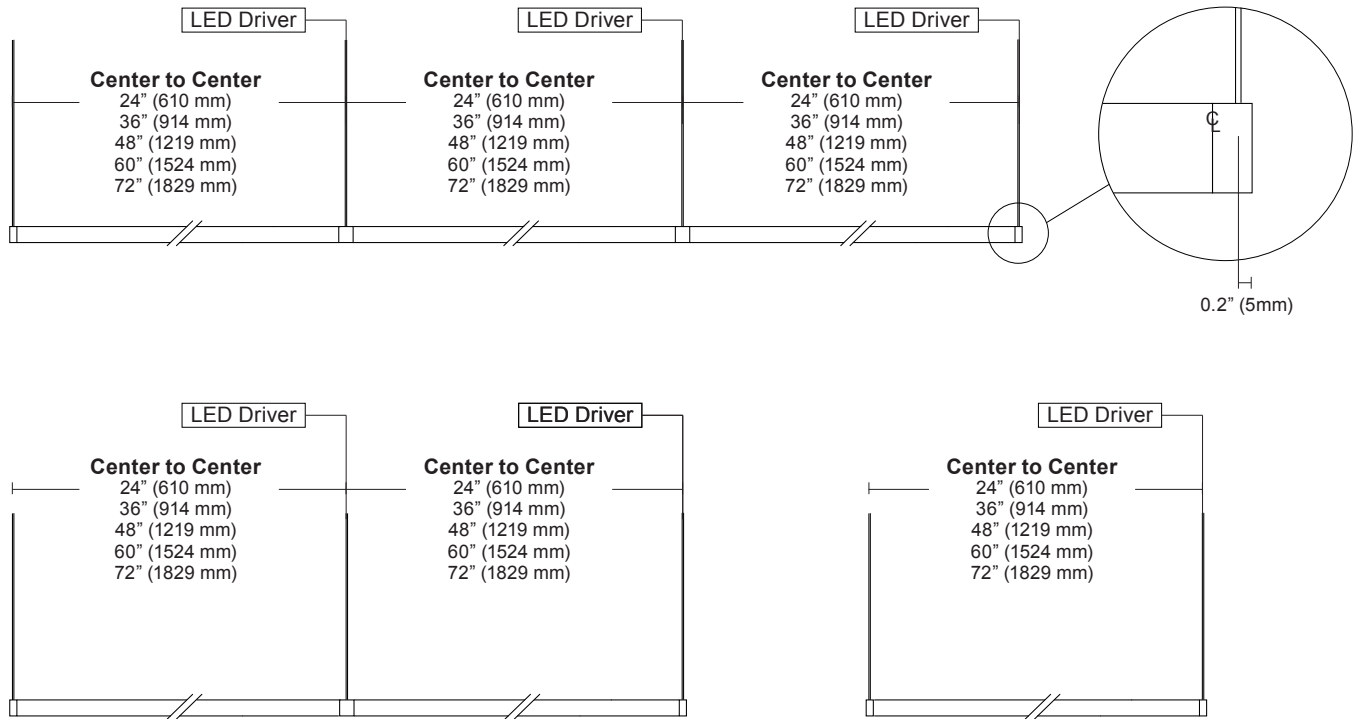

Corner and Shapes Available (Square, Rectangle, L-Shape, U-Shape, ZigZag) [See Guide](#) for details.

## Power and Controls

Power Type	Class 2 (<60V output) constant current driver.
Dimming Controls	Dimming (0.1%, 1%), 0-10V, DALI, DMX, Hi-lume 1% are available. <a href="#">See Power Guide</a> for details.
Input Voltage	120V - 277V, 50/60hz.
Power Location	Integral or remote power. Maximum remote distance up to 100' (30.5m) depending on driver selection. <a href="#">See Power Guide</a> for details.

Vode power locations fall into two categories: integral and remote. Remote power is locating the power supply away from the fixture. Remote power comes in two housing styles: brick style and linear style. Consult [Power Guide](#) to determine which type you will receive. Integral power is locating the power supply into the lighting fixture or mounting.

### Remote Brick Power Housing

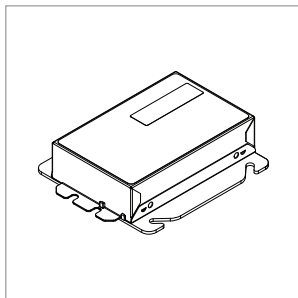

Supplied for some remote power applications. One remote power supply housing is supplied for each rail. Provided driver mounting plate fits standard 4" metal, square J-Boxes with a minimum volume of 21 in<sup>3</sup> (J-Box not provided). See [Tech Sheet](#) for details.

### Remote Linear Power Housing

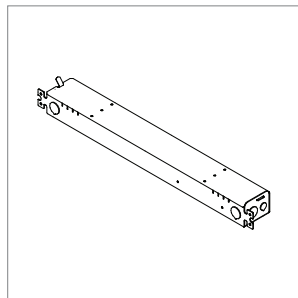

One remote power supply housing is supplied with each power supply. All Vode linear remote drivers come in a 0.054" (0.8mm) formed galvanized steel power supply housing with five (5) knockouts: (4) 1-1/8", (1) 7/8" and (1) 9/16". Accommodates standard linear power supplies. See [Tech Sheet](#) for details.

### Integral Power

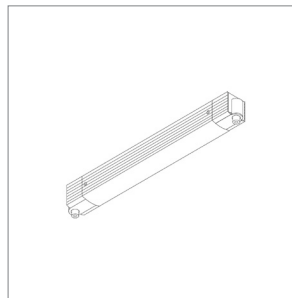

Houses integral power supply. Direct conduit feed is recommended, but integral power supply housing will mount to any standard North America 4" j-box. Mounts to most surfaces. Blocking is recommended at all arm junctions. See [Tech Sheet](#) for details.

### Wire Harness

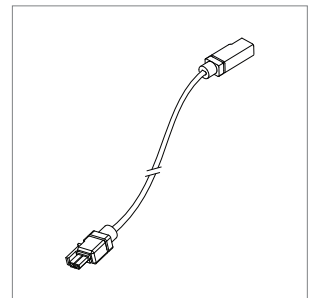

Wire harness connects driver to rail section. Lengths of 10' (3.0m) & 25' (7.6m) with snap-lock connectors for quick and easy installation. Multiple harnesses may be combined for lengths up to 100' (30.5m). See [Tech Sheet](#) for details.

## vodeCONNECT Sensors

Canopy with integrated sensor

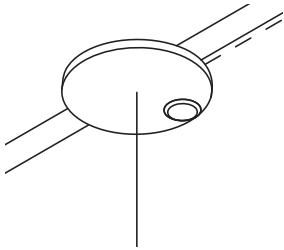

Sensor partners



### Integrated canopy sensor layout <sup>1</sup>

1 sensor per fixture. See [vodeCONNECT brochure](#) for more details.

NOTES: 1. Available with Large Round Canopy only.

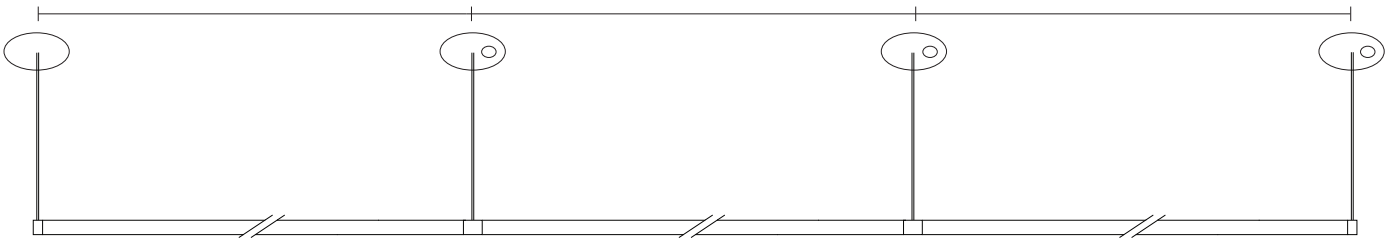

### Compatible sensors



Lutron Athena



Legrand Wattstopper



Enlighted Micro Sensor



## Power and Controls

### Flexible 1 to 1 power

For Flexible 1 to 1 Power, Vode supplies one single output driver per fixture, allowing each fixture to be controlled independently. Direct/Indirect fixtures are supplied with two single output drivers, allowing the direct and indirect lighting to be controlled independently. Consult [Power Guide](#) to determine which type you will receive.

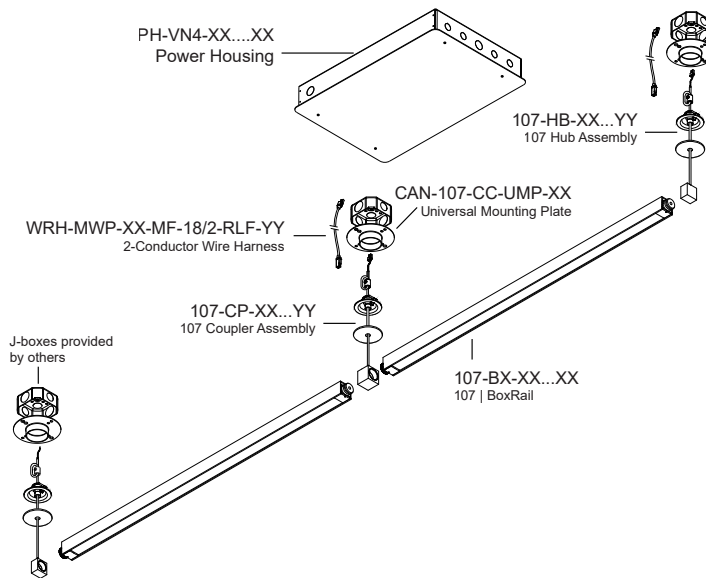

### Optimized Power

To optimize power, Vode configures specifications with drivers that have 2 or 4 outputs. Depending on system configurations and power requirements, up to 4 fixtures can be powered from a 4-output driver. Consult [Power Guide](#) to determine which type you will receive.

**IMPORTANT:** Each fixture will still require individual wire harnesses, as shown below.

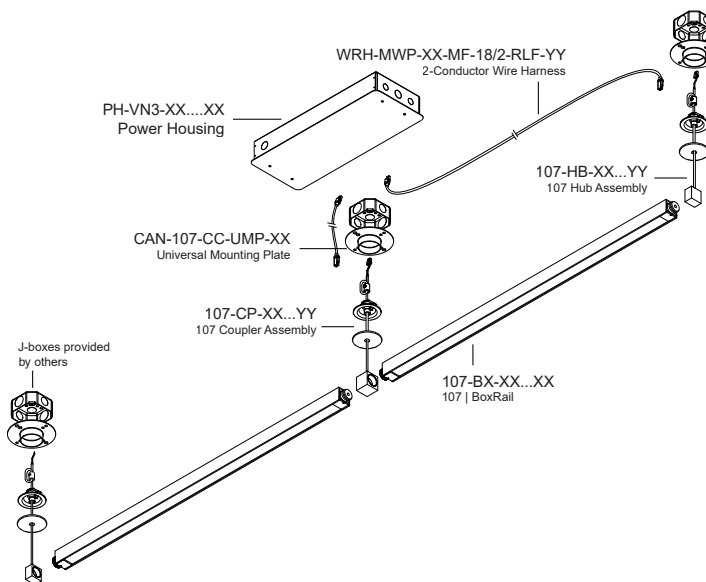

Note: Drawings not to scale, for reference only.

## Finish

Clear Anodized Finish



Clear Anodized Rail, White Canopy/Integral Power, White Cable

White Powder Coat Finish



White Rail, White Canopy/Integral Power, White Cable

Black Anodized Finish



Black Rail, Black Canopy/Integral Power, Black Cable

## Performance | Zipper Board Optics

Zipper Board Optics design has 72 diodes per foot (305mm).

Diffuse (1)

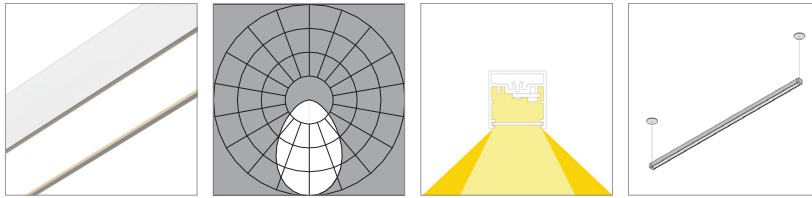

L90 >100,000 hours

	80 CRI (80min., 84 avg.)				90 CRI (90min., 96 avg.)			
	2700K	3000K	3500K	4000K	2700K	3000K	3500K	4000K
<b>Low Output (LO)</b>								
Efficacy - Lumens per Watt	76	79	79	79	66	68	69	71
Lumens per foot (305mm)	283	292	295	305	244	252	257	262
Watts per foot (305mm)	3.8	3.8	3.8	3.8	3.8	3.8	3.8	3.8
<b>Standard Output (SO)</b>								
Efficacy - Lumens per Watt	94	97	98	98	82	84	86	88
Lumens per foot (305mm)	566	584	589	589	489	504	515	525
Watts per foot (305mm)	6.1	6.1	6.1	6.1	6.1	6.1	6.1	6.1
<b>High Output (HO)</b>								
Efficacy - Lumens per Watt	88	91	92	92	76	78	80	82
Lumens per foot (305mm)	1075	1109	1120	1120	929	958	978	997
Watts per foot (305mm)	12.4	12.4	12.4	12.4	12.4	12.4	12.4	12.4

## Performance | Zipper Board Optics

Zipper Board Optics design has 72 diodes per foot (305mm).

### White Baffle (WB)

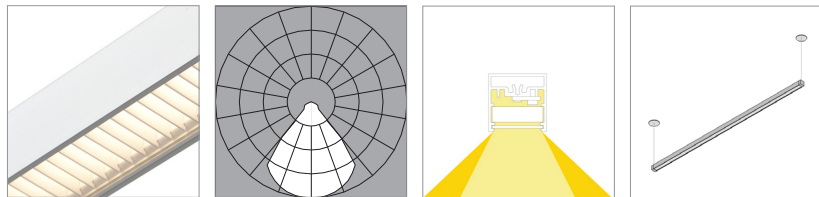

L90 >100,000 hours

	2700K	80 CRI (80min., 84 avg.)				90 CRI (90min., 96 avg.)			
		3000K	3500K	4000K	2700K	3000K	3500K	4000K	
<b>Low Output (LO)</b>									
Efficacy - Lumens per Watt	52	54	54	55	44	47	47	48	
Lumens per foot (305mm)	191	201	201	205	164	173	173	177	
Watts per foot (305mm)	3.8	3.8	3.8	3.8	3.8	3.8	3.8	3.8	

### Standard Output (SO)

Efficacy - Lumens per Watt	64	66	67	67	55	57	58	59
Lumens per foot (305mm)	381	393	401	401	329	339	346	353
Watts per foot (305mm)	6.1	6.1	6.1	6.1	6.1	6.1	6.1	6.1

### High Output (HO)

Efficacy - Lumens per Watt	59	61	62	64	51	53	54	55
Lumens per foot (305mm)	725	748	763	778	625	644	658	671
Watts per foot (305mm)	12.4	12.4	12.4	12.4	12.4	12.4	12.4	12.4

### Black Baffle (BB)

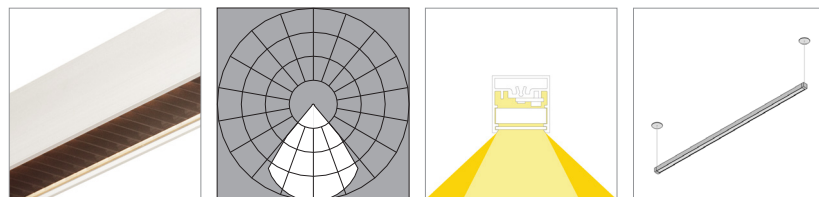

L90 >100,000 hours

	2700K	80 CRI (80min., 84 avg.)				90 CRI (90min., 96 avg.)			
		3000K	3500K	4000K	2700K	3000K	3500K	4000K	
<b>Low Output (LO)</b>									
Efficacy - Lumens per Watt	28	30	30	31	25	26	26	26	
Lumens per foot (305mm)	105	110	110	112	90	95	95	97	
Watts per foot (305mm)	3.8	3.8	3.8	3.8	3.8	3.8	3.8	3.8	

### Standard Output (SO)

Efficacy - Lumens per Watt	35	36	37	38	30	31	32	33
Lumens per foot (305mm)	209	216	220	225	180	186	190	194
Watts per foot (305mm)	6.1	6.1	6.1	6.1	6.1	6.1	6.1	6.1

### High Output (HO)

Efficacy - Lumens per Watt	33	34	35	35	28	29	30	30
Lumens per foot (305mm)	397	410	418	427	343	353	361	368
Watts per foot (305mm)	12.4	12.4	12.4	12.4	12.4	12.4	12.4	12.4

## Performance | Zipper Board Optics

Zipper Board Optics design has 72 diodes per foot (305mm).

### 120° Batwing (G1)

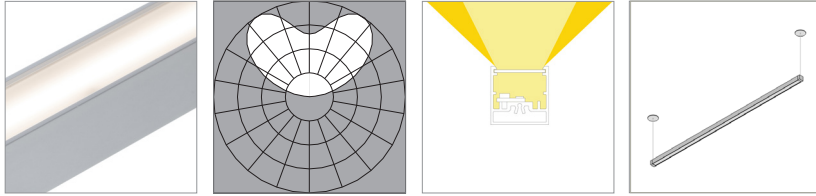

L90 >100,000 hours

	80 CRI (80min., 84 avg.)				90 CRI (90min., 96 avg.)			
	2700K	3000K	3500K	4000K	2700K	3000K	3500K	4000K
<b>Low Output (LO)</b>								
Efficacy - Lumens per Watt	98	101	103	105	84	87	89	91
Lumens per foot (305mm)	364	375	383	391	314	323	330	337
Watts per foot (305mm)	3.8	3.8	3.8	3.8	3.8	3.8	3.8	3.8
<b>Standard Output (SO)</b>								
Efficacy - Lumens per Watt	122	126	128	131	105	109	111	113
Lumens per foot (305mm)	727	750	766	781	627	647	660	673
Watts per foot (305mm)	6.1	6.1	6.1	6.1	6.1	6.1	6.1	6.1
<b>High Output (HO)</b>								
Efficacy - Lumens per Watt	113	116	119	121	97	100	102	104
Lumens per foot (305mm)	1382	1426	1455	1484	1192	1229	1254	1279
Watts per foot (305mm)	12.4	12.4	12.4	12.4	12.4	12.4	12.4	12.4

### 120° FlyWing (G2)

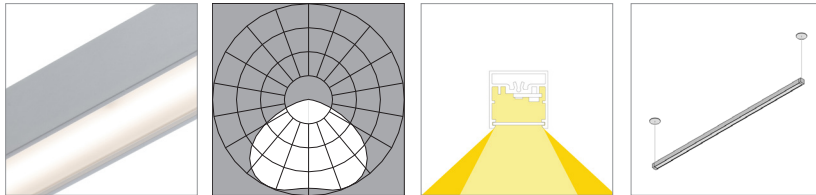

L90 >100,000 hours

	80 CRI (80min., 84 avg.)				90 CRI (90min., 96 avg.)			
	2700K	3000K	3500K	4000K	2700K	3000K	3500K	4000K
<b>Low Output (LO)</b>								
Efficacy - Lumens per Watt	90	93	95	97	78	80	82	83
Lumens per foot (305mm)	335	346	353	360	289	298	304	310
Watts per foot (305mm)	3.8	3.8	3.8	3.8	3.8	3.8	3.8	3.8
<b>Standard Output (SO)</b>								
Efficacy - Lumens per Watt	112	115	118	120	96	99	101	103
Lumens per foot (305mm)	670	691	705	719	578	596	608	620
Watts per foot (305mm)	6.1	6.1	6.1	6.1	6.1	6.1	6.1	6.1
<b>High Output (HO)</b>								
Efficacy - Lumens per Watt	104	107	109	112	90	93	94	96
Lumens per foot (305mm)	1273	1313	1340	1367	1098	1132	1155	1178
Watts per foot (305mm)	12.4	12.4	12.4	12.4	12.4	12.4	12.4	12.4

## Performance | Zipper Board Optics

Zipper Board Optics design has 72 diodes per foot (305mm).

### 40° Symmetric (S1)

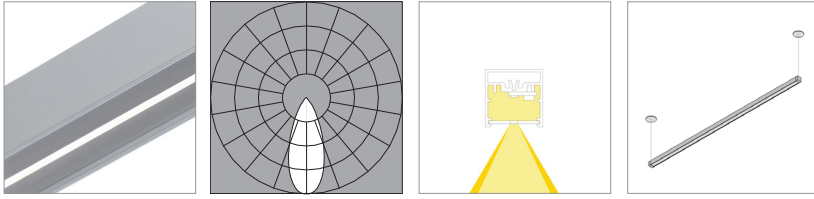

L90 >100,000 hours

	80 CRI (80min., 84 avg.)				90 CRI (90min., 96 avg.)			
	2700K	3000K	3500K	4000K	2700K	3000K	3500K	4000K
<b>Low Output (LO)</b>								
Efficacy - Lumens per Watt	42	43	44	45	36	37	38	39
Lumens per foot (305mm)	154	159	162	165	133	137	140	142
Watts per foot (305mm)	3.8	3.8	3.8	3.8	3.8	3.8	3.8	3.8

### Standard Output (SO)

Efficacy - Lumens per Watt	52	53	54	55	45	46	47	48
Lumens per foot (305mm)	308	317	324	330	265	273	279	285
Watts per foot (305mm)	6.1	6.1	6.1	6.1	6.1	6.1	6.1	6.1

### High Output (HO)

Efficacy - Lumens per Watt	48	49	50	51	41	43	44	44
Lumens per foot (305mm)	584	603	615	627	504	520	530	541
Watts per foot (305mm)	12.4	12.4	12.4	12.4	12.4	12.4	12.4	12.4

### 60° Symmetric (S2)

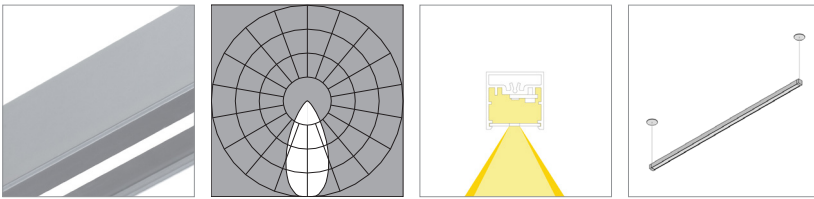

L90 >100,000 hours

	80 CRI (80min., 84 avg.)				90 CRI (90min., 96 avg.)			
	2700K	3000K	3500K	4000K	2700K	3000K	3500K	4000K
<b>Low Output (LO)</b>								
Efficacy - Lumens per Watt	52	53	54	55	45	46	47	48
Lumens per foot (305mm)	191	197	201	205	165	170	173	177
Watts per foot (305mm)	3.8	3.8	3.8	3.8	3.8	3.8	3.8	3.8

### Standard Output (SO)

Efficacy - Lumens per Watt	64	66	67	69	55	57	58	59
Lumens per foot (305mm)	382	394	402	410	329	340	347	354
Watts per foot (305mm)	6.1	6.1	6.1	6.1	6.1	6.1	6.1	6.1

### High Output (HO)

Efficacy - Lumens per Watt	59	61	63	64	51	53	54	55
Lumens per foot (305mm)	726	749	764	779	626	646	659	672
Watts per foot (305mm)	12.4	12.4	12.4	12.4	12.4	12.4	12.4	12.4

## Performance | Zipper Board Optics

Zipper Board Optics design has 72 diodes per foot (305mm).

### 85° Asymmetric (A1)

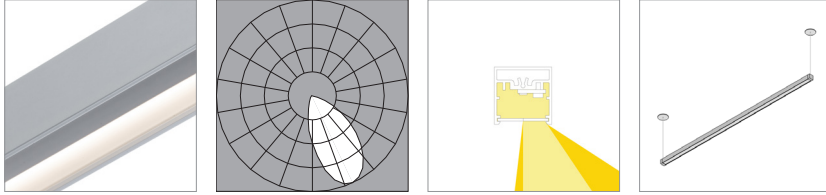

L90 >100,000 hours

	80 CRI (80min., 84 avg.)				90 CRI (90min., 96 avg.)			
	2700K	3000K	3500K	4000K	2700K	3000K	3500K	4000K
<b>Low Output (LO)</b>								
Efficacy - Lumens per Watt	66	68	69	71	57	59	60	61
Lumens per foot (305mm)	244	252	257	262	210	217	221	226
Watts per foot (305mm)	3.8	3.8	3.8	3.8	3.8	3.8	3.8	3.8

### Standard Output (SO)

Efficacy - Lumens per Watt	75	77	79	80	65	67	68	69
Lumens per foot (305mm)	488	503	513	524	420	434	443	451
Watts per foot (305mm)	6.6	6.6	6.6	6.6	-	-	-	-

### High Output (HO)

Efficacy - Lumens per Watt	76	78	80	81	65	67	69	70
Lumens per foot (305mm)	927	956	975	995	799	824	841	858
Watts per foot (305mm)	12.4	12.4	12.4	12.4	12.4	12.4	12.4	12.4

### 40° Symmetric, black finish (S1-BL)

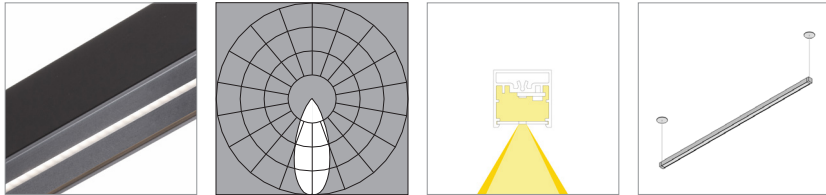

L90 >100,000 hours

	80 CRI (80min., 84 avg.)				90 CRI (90min., 96 avg.)			
	2700K	3000K	3500K	4000K	2700K	3000K	3500K	4000K
<b>Low Output (LO)</b>								
Efficacy - Lumens per Watt	32	33	33	34	28	29	29	30
Lumens per foot (305mm)	117	121	123	126	101	104	106	108
Watts per foot (305mm)	3.8	3.8	3.8	3.8	3.8	3.8	3.8	3.8

### Standard Output (SO)

Efficacy - Lumens per Watt	39	41	41	42	34	35	36	37
Lumens per foot (305mm)	234	242	247	252	202	208	213	217
Watts per foot (305mm)	6.1	6.1	6.1	6.1	6.1	6.1	6.1	6.1

### High Output (HO)

Efficacy - Lumens per Watt	37	38	39	39	32	33	33	34
Lumens per foot (305mm)	445	459	469	478	384	396	404	412
Watts per foot (305mm)	12.4	12.4	12.4	12.4	12.4	12.4	12.4	12.4

## Performance | Zipper Board Optics

Zipper Board Optics design has 72 diodes per foot (305mm).

### 60° Symmetric, black finish (S2-BL)

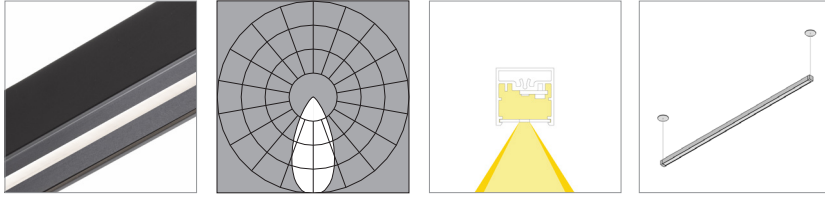

L90 >100,000 hours

Low Output (LO)	2700K	80 CRI (80min., 84 avg.)				2700K	90 CRI (90min., 96 avg.)		
		3000K	3500K	4000K	3000K		3500K	4000K	
Efficacy - Lumens per Watt	39	40	41	41	33	34	35	36	
Lumens per foot (305mm)	142	147	150	153	123	127	129	132	
Watts per foot (305mm)	3.8	3.8	3.8	3.8	3.8	3.8	3.8	3.8	

### Standard Output (SO)

Efficacy - Lumens per Watt	48	49	50	51	41	43	43	44
Lumens per foot (305mm)	285	294	300	306	245	253	258	263
Watts per foot (305mm)	6.1	6.1	6.1	6.1	6.1	6.1	6.1	6.1

### High Output (HO)

Efficacy - Lumens per Watt	44	46	47	48	38	40	40	41
Lumens per foot (305mm)	541	558	569	581	446	481	491	501
Watts per foot (305mm)	12.4	12.4	12.4	12.4	12.4	12.4	12.4	12.4

### 85° Asymmetric, black finish (A1-BL)

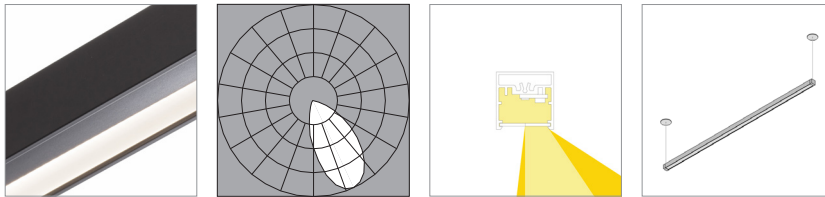

L90 >100,000 hours

Low Output (LO)	2700K	80 CRI (80min., 84 avg.)				2700K	90 CRI (90min., 96 avg.)		
		3000K	3500K	4000K	3000K		3500K	4000K	
Efficacy - Lumens per Watt	35	36	36	37	30	31	32	32	
Lumens per foot (305mm)	128	132	134	137	110	114	116	118	
Watts per foot (305mm)	3.8	3.8	3.8	3.8	3.8	3.8	3.8	3.8	

### Standard Output (SO)

Efficacy - Lumens per Watt	43	44	45	46	37	38	39	40
Lumens per foot (305mm)	255	263	269	274	220	227	232	236
Watts per foot (305mm)	6.1	6.1	6.1	6.1	6.1	6.1	6.1	6.1

### High Output (HO)

Efficacy - Lumens per Watt	40	41	42	43	34	36	36	37
Lumens per foot (305mm)	485	501	511	521	418	431	440	449
Watts per foot (305mm)	12.4	12.4	12.4	12.4	12.4	12.4	12.4	12.4

Copyright © 2024 Vode Lighting LLC. All rights reserved. Vode, the Vode logo, BoxRail, FlyWing, MicroBaffle, Button Board, Zipper Board, Zero Canopy, Zero Block, VodeNODE and other names are either registered trademarks or trademarks of Vode Lighting LLC in the United States and may be registered in other countries. All other trademarks listed herein belong to their respective owners. Due to ongoing innovation, specification details may change without notice.