

Spec Guide

BoxRail | Ceiling Cable | 207



Incredible direct/indirect performance in Vode's small square form.



BoxRail 207

Benefits & Features

Minimal Profile

Double Rail performance in a small square profile, 1.14" (29mm) x 1.14" (29mm).

Superior Light Quality & Performance

Output up to 3102 lm/ft (HO), 132 lm/W (HO). 90 CRI static & tunable white 2200K - 5000K. Custom ranges available upon request.

High Performance Optics

Break through Batwing lens designed for excellent fixture to fixture spacing.

Continuous Line of Light

Continuous line of light between rail sections.

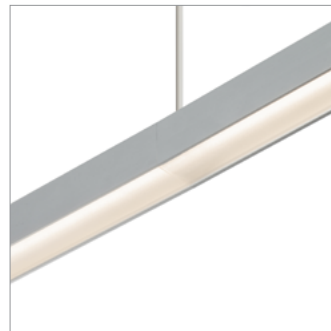

Continuous line of light

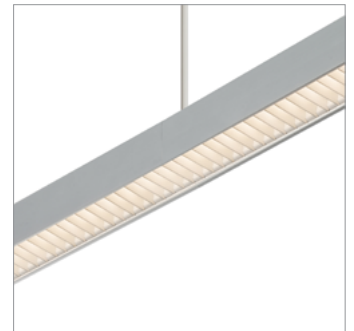

Continuous line of light, baffle

Applications

General Interior and Open Office

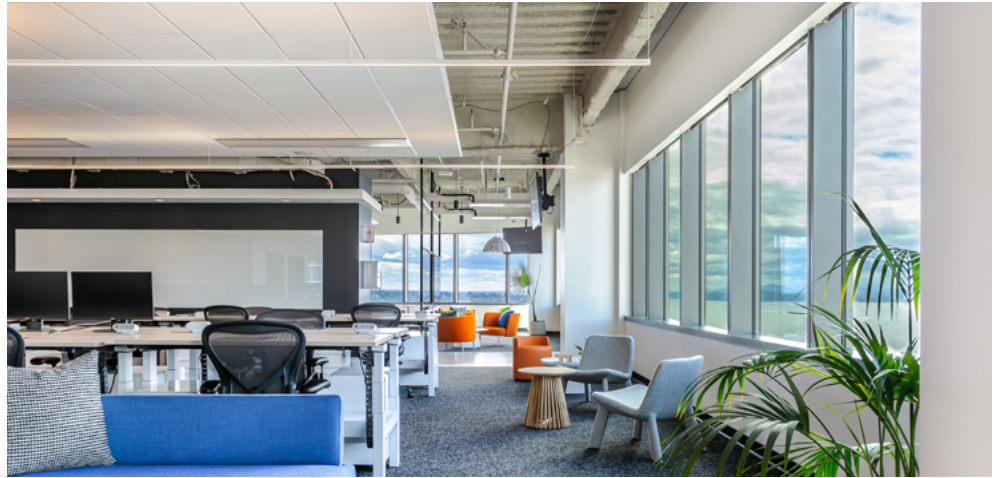

Indeed, Seattle, WA



Indeed, Seattle, WA



Indeed, Seattle, WA

Declare Label

All Vode Lighting linear light fixtures proudly carry the Red List Approved designation.

See [International Living Future Institute](https://www.living-future.org) website for details.



Declare.

Vode Adaptive Architectural Lighting Systems

Vode Lighting LLC

Final Assembly: Sonoma, California, US
Life Expectancy: 10+ Year(s)
End of Life Options: Recyclable (100%)

Ingredients:

Anodized Aluminum (6063-T5 Alloy); Steel; Small Electrical Component (RoHS)¹; Copper; **Fluorinated Ethylene Propylene (masterbatch)**²; Polymethyl methacrylate (PMMA); Stainless Steel; Polyoxymethylene Copolymer (POM); Styrene-butadiene polymer, hydrogenated; Poly(methyl methacrylate/butyl acrylate/styrene) (PMMA/BA/S); Styrene/butadiene copolymer; Distillates; Polypropylene; Calcium carbonate; Polycarbonate; EVA Copolymer; Methyl methacrylate (MMA); Polyphenylene Oxide; Brass; Tin, Organic

¹LBC Temp Exception RL-002 - Small Electrical Components
²LBC Temp Exception RL-023 - Wire Sheathing Subject to NFPA 90A, NFPA 262, UL® 910

Living Building Challenge Criteria: Compliant

I-13 Red List:

<input type="checkbox"/> LBC Red List Free	% Disclosed: 100% at 100ppm
<input checked="" type="checkbox"/> LBC Red List Approved	VOC Content: Not Applicable
<input type="checkbox"/> Declared	

I-10 Interior Performance: Not Applicable
I-14 Responsible Sourcing: Not Applicable

VDE-0001
 EXP. 01 JAN 2025
 Original Issue Date: 2018

MANUFACTURER RESPONSIBLE FOR LABEL ACCURACY
 INTERNATIONAL LIVING FUTURE INSTITUTE™ living-future.org/declare



Structure

Rail Lengths	24" (610mm) - 144" (3658mm). Modified lengths available. See Rail Length Chart for more details.
Rail Dimensions	1.14" (29mm) x 1.14" (29mm) x length.
Construction	Extruded and machined 6063 aluminum.
Mounting	Ceiling mount to jbox or driver housing.
Cable Length	48" (1220mm) and 96" (2438mm) available. Field adjustable. Non-standard cable lengths available.
System Run Length	24" (610mm) minimum. Unlimited maximum.
Operating Temperature	32°F to 104°F (0°C to 40°C).
Humidity	0-85%, non-condensing.
System Weight	0.65 lbs per ft (0.29kg per 305mm) Power supply and housing not included.

Materials

LED Board Construction	Aluminum core PCB, black LCP connectors, RoHS compliant.
Lens	High-impact extruded acrylic glass (PMMA).
Baffle	6063 aluminum, RoHS compliant painted finish.
Suspension Cable	Ø4mm, 22/4 AWG, TPE jacket, FEP-insulated, Red List Approved.
Power Cable	Ø4mm, 18/2 AWG, TPE jacket, FEP-insulated, Red List Approved.
Cable Connectors	Unfilled white nylon, rate UL 94 V-0, halogen free, FEP overmold, Red List Approved.
Remote Linear Power Housing (RLP)	20.7" x 2.375" x 0.054" formed galvanized steel.
Remote Brick Power Housing (RBP)	4.32" x 3.37" x 0.078" galvanized steel mounting plate.
Integral Power Housing	Extruded and machined 6063 aluminum.
Center Cable Suspension	3/64" aircraft cable.

Mounting Options

Remote Power

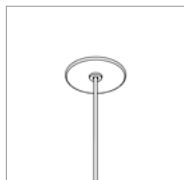

Small Round Canopy
Ø2.5" (51mm)

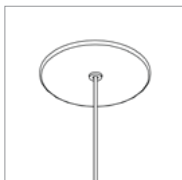

Large Round Canopy
Ø4.5" (114mm)

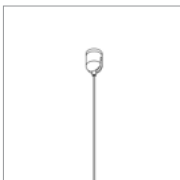

Center Support Cable
96" - 144" Rails Only
Center Support Cable for mounting to T-Bar tile available.

Integral Power (24"-72")

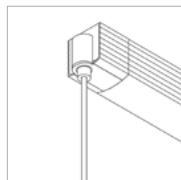

Integral Power (end)
h 1.8" (46mm)
w 1.7" (43mm)

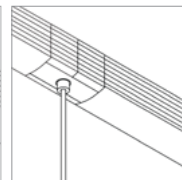

Integral Power (joint)

Dimensions

All rail lengths are nominal. The actual overall dimension of each overall system length is +0.63 (16mm).

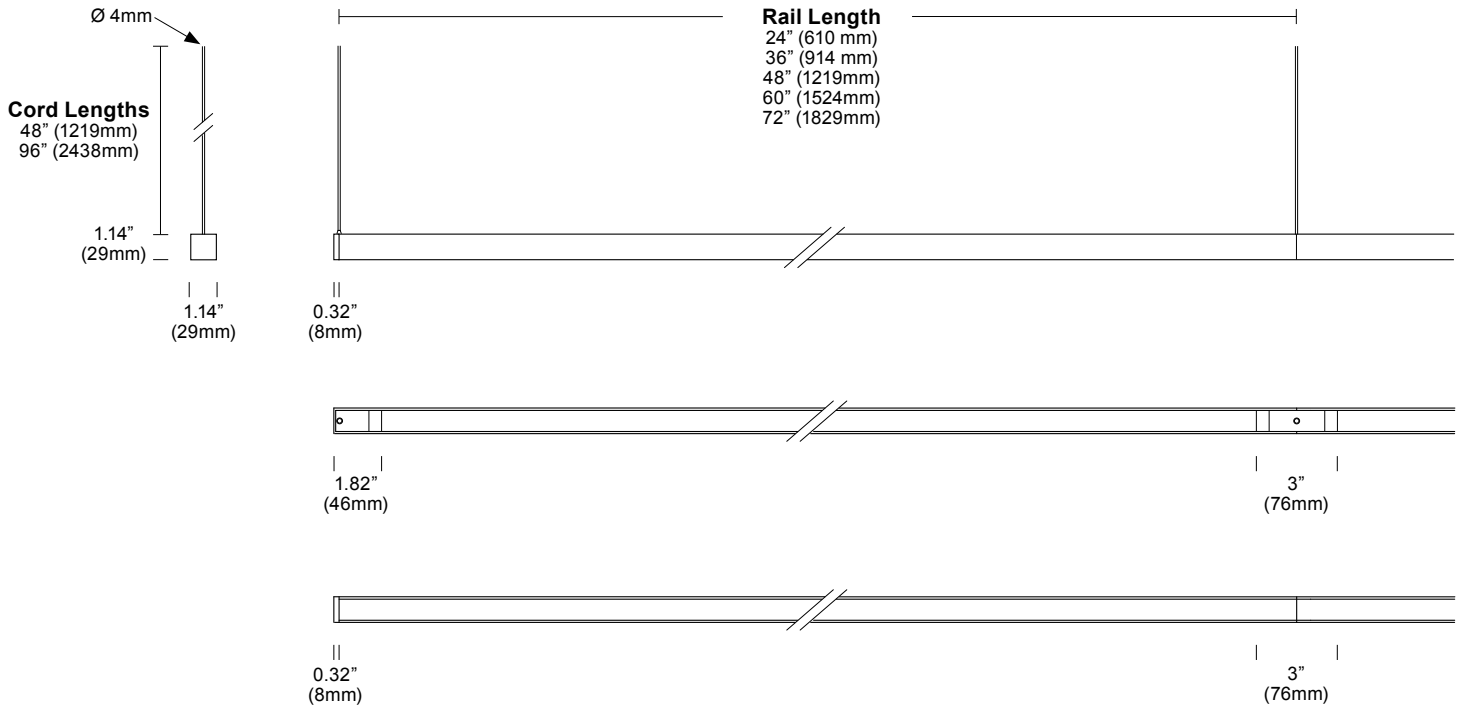

Layout

A typical power layout for dual direction fixtures is two drivers per rail. For single direction fixtures it is one driver per rail. Vode supplies one 25' (7.62m) wire harness per LED channel. Reference Vode's [Power Guide](#) for driver details. Corner and Shapes Available (Square, Rectangle, L-Shape, U-Shape)

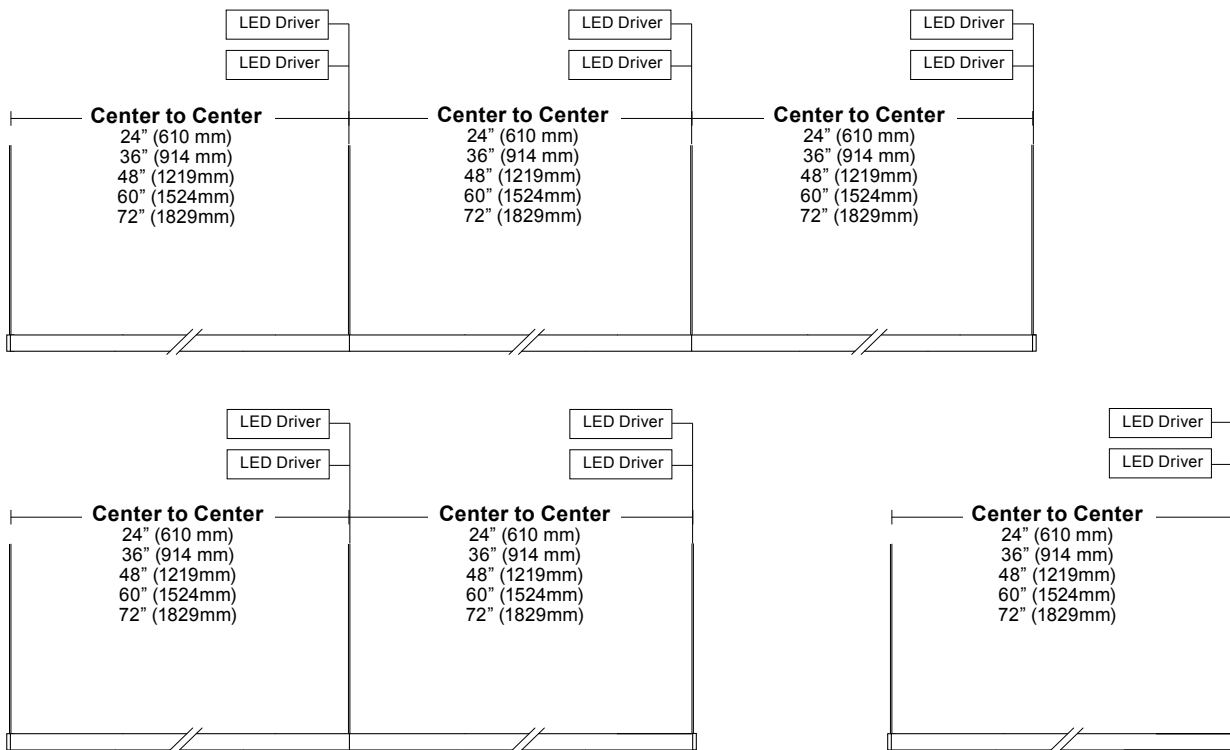

vodeCONNECT Sensors

Canopy with integrated sensor

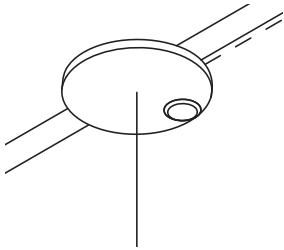

Sensor partners



Integrated canopy sensor layout ^{1,2}

1 sensor per fixture. See [vodeCONNECT brochure](#) for more details.

NOTES: 1. Available with Large Round Canopy only. 2. Sensors, drivers and control units that are integrated into Vode fixtures are discrete components that communicate with network lighting controls. For more information about each network lighting control system, visit the manufacturer's website for additional system information and technical data sheets. For general information about network lighting controls, consult the DesignLights Consortium® (DLC) [Networked Lighting Control Qualified Product List](#).

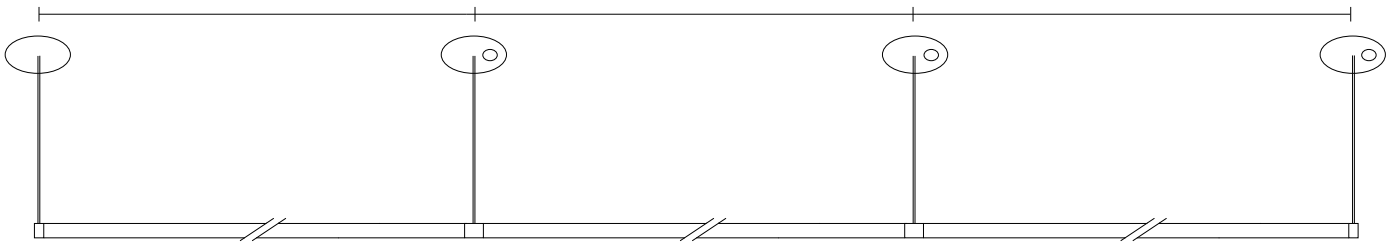

Compatible sensors



Lutron Athena



Legrand Wattstopper



Enlighted Micro Sensor

Power

Power Type	Class 2 (<60V output) constant current driver.
Controls	Dimming (0.1%, 1%), 0-10V, DALI, DMX, Hi-lume 1% are available. See Power Guide for details.
Input Voltage	120V - 277V, 50/60hz.
Power Location	Integral or remote power. Maximum remote distance up to 100' (30mm) depending on driver selection. See Power Guide for details.

Vode power locations fall into two categories: integral and remote. Remote power is locating the power supply away from the fixture. Remote power comes into two housing styles: brick style and linear style. Consult the [Power Guide](#) to determine which type you will receive. Integral power is locating the power supply into the lighting fixture or mounting. Vode provides one 25' (7.52m) plenum rated wire harness per LED channel.

Remote Brick Power Housing

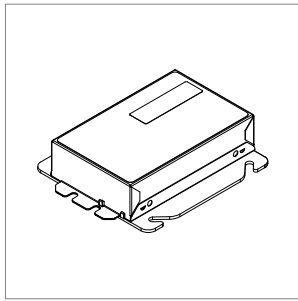

Mounting Plate: 4.32" x 3.37"

Supplied for some remote power applications. One remote power supply housing is supplied for each rail. Provided driver mounting plate fits standard 4" metal, square J-Boxes with a minimum volume of 21 in³ (J-Box not provided). See [Tech Sheet](#) for details.

Remote Linear Power Housing

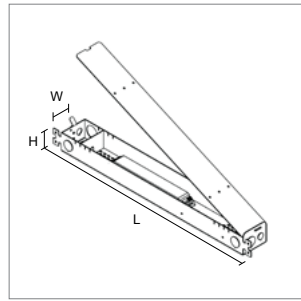

L: 20.7" (526mm)
H: 2.38" (61mm)
W: 2.53" (64mm)

One remote power supply housing is supplied with each power supply. All Vode linear remote drivers come in a 0.054" (0.8mm) formed galvanized steel power supply housing with five (5) knockouts: (4) 1-1/8", (1) 7/8" and (1) 9/16". Accommodates standard linear power supplies. See [Tech Sheet](#) for details.

Integral Power

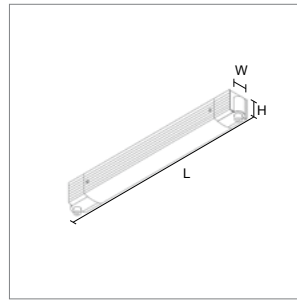

L: 24" - 72" (610mm - 1829mm)
H: 1.7" (43mm)
W: 1.8" (46mm)

Houses integral power supply. Direct conduit feed is recommended, but integral power supply housing will mount to any standard North America 4" j-box. Mounts to most surfaces. Blocking is recommended at all arm junctions. See [Tech Sheet](#) for details.

Wire Harness

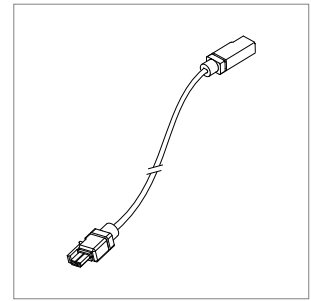

Wire harness connects driver to rail section. Lengths of 10' (3.0m) & 25' (7.6m) with snap-lock connectors for quick and easy installation. Multiple harnesses may be combined for lengths up to 100' (30.5m). See [Tech Sheet](#) for details.

Power and Controls

Flexible 1 to 1 power

For Flexible 1 to 1 Power, Vode supplies one single output driver per fixture, allowing each fixture to be controlled independently. Direct/Indirect fixtures are supplied with two single output drivers, allowing the direct and indirect lighting to be controlled independently. Consult [Power Guide](#) to determine which type you will receive.

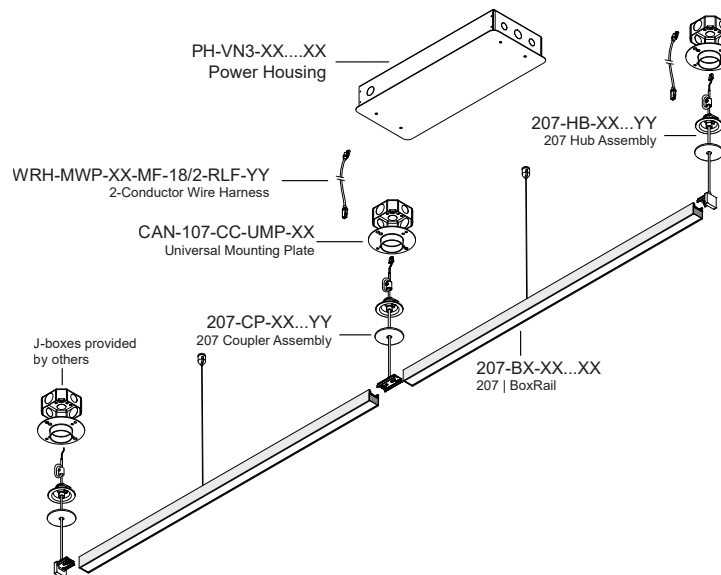

Note: Drawings not to scale, for reference only.

Power and Controls

Optimized Power

To optimize power, Vode configures specifications with drivers that have 2 or 4 outputs. Depending on system configurations and power requirements, up to 4 fixtures can be powered from a 4-output driver. Consult [Power Guide](#) to determine which type you will receive.

IMPORTANT: Each fixture will still require individual wire harnesses, as shown below.

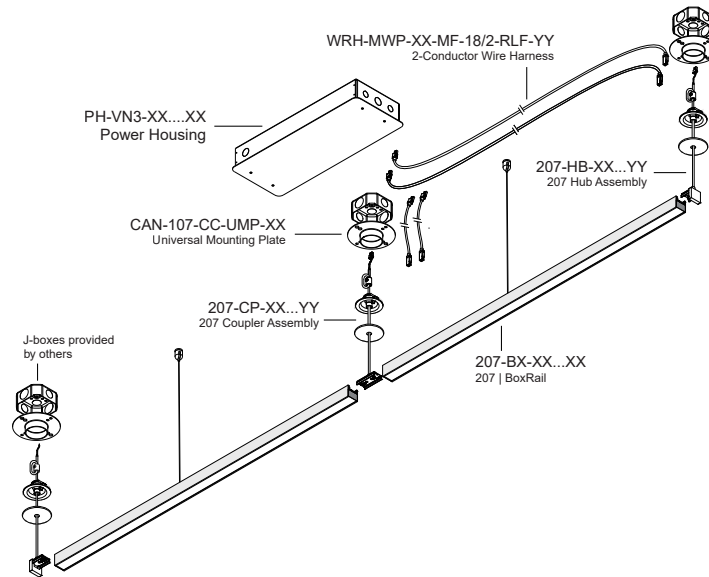

Note: Drawings not to scale, for reference only.

Finish

Clear Anodized Finish



Clear Anodized Rail, White Canopy/Clear Anodized Integral Power, White Cable

White Powder Coat Finish



White Rail, White Canopy/Integral Power, White Cable

Black Anodized Finish



Black Rail, Black Canopy/Integral Power, Black Cable

Performance | Zipper Board Optics

Zipper Board Optics design has 72 diodes per foot (305mm).

Wide Batwing, up | Diffuse, down (G1D1)

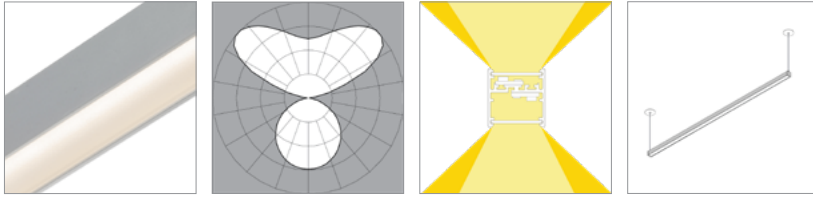

L90 >100,000 hours

90 CRI (90min., 96 avg.)

Low Output (LO)	2700K	3000K	3500K	4000K
Efficacy - Lumens per Watt	77	80	81	82
Lumens per foot (305mm)	551	569	580	586
Watts per foot (305mm)	7.2	7.2	7.2	7.2

Standard Output (SO)

Efficacy - Lumens per Watt	88	91	92	93
Lumens per foot (305mm)	1102	1137	1160	1172
Watts per foot (305mm)	12.7	12.7	12.7	12.7

High Output (HO)

Efficacy - Lumens per Watt	82	84	86	87
Lumens per foot (305mm)	2095	2161	2205	2227
Watts per foot (305mm)	25.8	25.8	25.8	25.8

Wide Batwing, up | Diffuse, down, black finish (G1D1-BL)

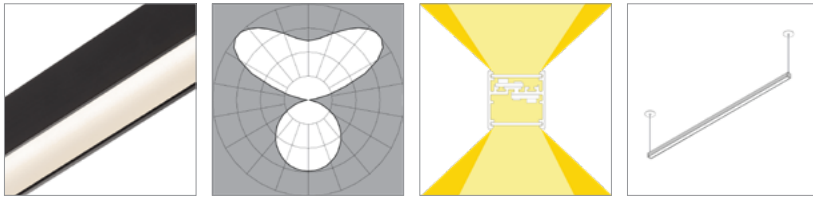

L90 >100,000 hours

90 CRI (90min., 96 avg.)

Low Output (LO)	2700K	3000K	3500K	4000K
Efficacy - Lumens per Watt	67	69	71	71
Lumens per foot (305mm)	478	493	503	508
Watts per foot (305mm)	7.2	7.2	7.2	7.2

Standard Output (SO)

Efficacy - Lumens per Watt	76	79	81	81
Lumens per foot (305mm)	956	987	1007	1017
Watts per foot (305mm)	12.7	12.7	12.6	12.7

High Output (HO)

Efficacy - Lumens per Watt	71	73	75	75
Lumens per foot (305mm)	1817	1875	1913	1932
Watts per foot (305mm)	25.8	25.8	25.8	25.8

Performance | Zipper Board Optics

Zipper Board Optics design has 72 diodes per foot (305mm).

Wide Batwing, up | White Baffle, down (G1WB)

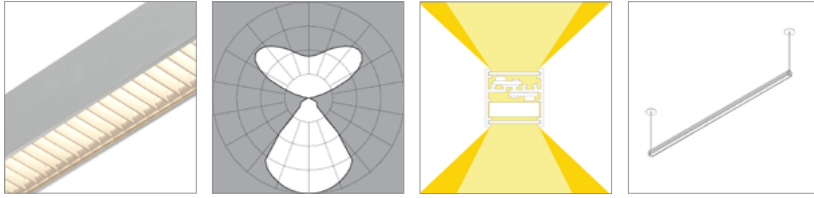

L90 >100,000 hours

90 CRI (90min., 96 avg.)

Low Output (LO)	2700K	3000K	3500K	4000K
Efficacy - Lumens per Watt	75	77	79	80
Lumens per foot (305mm)	535	552	563	569
Watts per foot (305mm)	7.2	7.2	7.2	7.2

Standard Output (SO)

Efficacy - Lumens per Watt	85	88	89	91
Lumens per foot (305mm)	1070	1104	1126	1138
Watts per foot (305mm)	12.7	12.7	12.7	12.7

High Output (HO)

Efficacy - Lumens per Watt	79	82	84	84
Lumens per foot (305mm)	2033	2097	2140	2162
Watts per foot (305mm)	25.8	25.8	25.8	25.8

Wide Batwing, up | White Baffle, down, black finish (G1WB-BL)

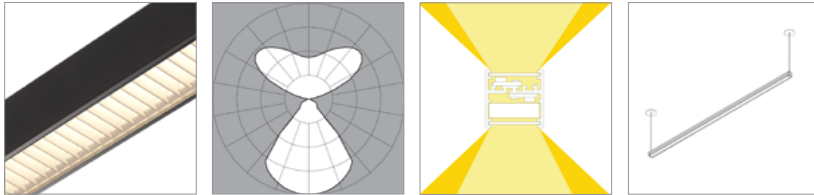

L90 >100,000 hours

90 CRI (90min., 96 avg.)

Low Output (LO)	2700K	3000K	3500K	4000K
Efficacy - Lumens per Watt	67	69	70	71
Lumens per foot (305mm)	475	490	500	505
Watts per foot (305mm)	7.2	7.2	7.2	7.2

Standard Output (SO)

Efficacy - Lumens per Watt	76	78	80	81
Lumens per foot (305mm)	951	981	1001	1011
Watts per foot (305mm)	12.7	12.7	12.6	12.7

High Output (HO)

Efficacy - Lumens per Watt	71	73	74	75
Lumens per foot (305mm)	1806	1863	1901	1920
Watts per foot (305mm)	25.8	25.8	25.8	25.8

Performance | Zipper Board Optics

Zipper Board Optics design has 72 diodes per foot (305mm).

Wide Batwing, up | Black Baffle, down (G1BB)

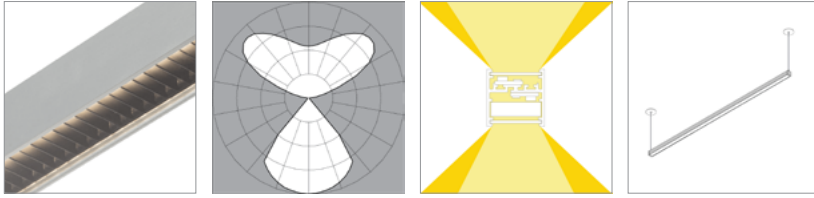

L90 >100,000 hours

90 CRI (90min., 96 avg.)

Low Output (LO)	2700K	3000K	3500K	4000K
Efficacy - Lumens per Watt	60	62	63	64
Lumens per foot (305mm)	429	442	451	456
Watts per foot (305mm)	7.2	7.2	7.2	7.2

Standard Output (SO)	2700K	3000K	3500K	4000K
Efficacy - Lumens per Watt	68	71	72	73
Lumens per foot (305mm)	857	884	902	911
Watts per foot (305mm)	12.7	12.7	12.6	12.7

High Output (HO)	2700K	3000K	3500K	4000K
Efficacy - Lumens per Watt	64	66	67	68
Lumens per foot (305mm)	1629	1680	1714	1732
Watts per foot (305mm)	25.8	25.8	25.8	25.8

Wide Batwing, up | Black Baffle, down, black finish (G1BB-BL)

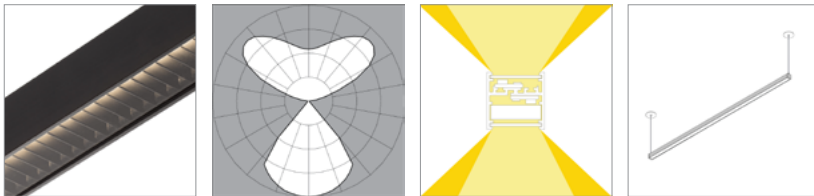

L90 >100,000 hours

90 CRI (90min., 96 avg.)

Low Output (LO)	2700K	3000K	3500K	4000K
Efficacy - Lumens per Watt	57	59	60	60
Lumens per foot (305mm)	404	417	426	430
Watts per foot (305mm)	7.2	7.2	7.2	7.2

Standard Output (SO)	2700K	3000K	3500K	4000K
Efficacy - Lumens per Watt	65	67	68	69
Lumens per foot (305mm)	809	834	851	860
Watts per foot (305mm)	12.7	12.7	12.6	12.7

High Output (HO)	2700K	3000K	3500K	4000K
Efficacy - Lumens per Watt	60	62	63	64
Lumens per foot (305mm)	1537	1585	1617	1634
Watts per foot (305mm)	25.8	25.8	25.8	25.8

Performance | Zipper Board Optics

Zipper Board Optics design has 72 diodes per foot (305mm).

Wide Batwing, up | 40° Symmetric, down (G1S1)

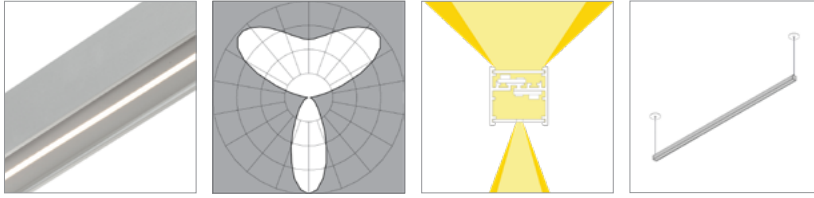

L90 >100,000 hours

90 CRI (90min., 96 avg.)

Low Output (LO)	2700K	3000K	3500K	4000K
Efficacy - Lumens per Watt	66	68	69	70
Lumens per foot (305mm)	469	484	494	499
Watts per foot (305mm)	7.2	7.2	7.2	7.2

Standard Output (SO)	2700K	3000K	3500K	4000K
Efficacy - Lumens per Watt	75	77	79	79
Lumens per foot (305mm)	938	968	988	998
Watts per foot (305mm)	12.7	12.7	12.6	12.7

High Output (HO)	2700K	3000K	3500K	4000K
Efficacy - Lumens per Watt	70	72	73	74
Lumens per foot (305mm)	1783	1839	1877	1895
Watts per foot (305mm)	25.8	25.8	25.8	25.8

Wide Batwing, up | 40° Symmetric, down, black finish (G1S1-BL)

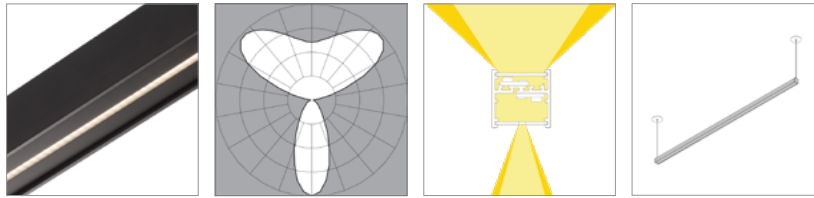

L90 >100,000 hours

90 CRI (90min., 96 avg.)

Low Output (LO)	2700K	3000K	3500K	4000K
Efficacy - Lumens per Watt	55	57	58	58
Lumens per foot (305mm)	392	405	413	417
Watts per foot (305mm)	7.2	7.2	7.2	7.2

Standard Output (SO)	2700K	3000K	3500K	4000K
Efficacy - Lumens per Watt	63	65	66	67
Lumens per foot (305mm)	784	809	826	834
Watts per foot (305mm)	12.7	12.7	12.6	12.7

High Output (HO)	2700K	3000K	3500K	4000K
Efficacy - Lumens per Watt	58	60	61	62
Lumens per foot (305mm)	1490	1538	1569	1585
Watts per foot (305mm)	25.8	25.8	25.8	25.8

Performance | Zipper Board Optics

Zipper Board Optics design has 72 diodes per foot (305mm).

Wide Batwing, up | 60° Symmetric, down (G1S2)

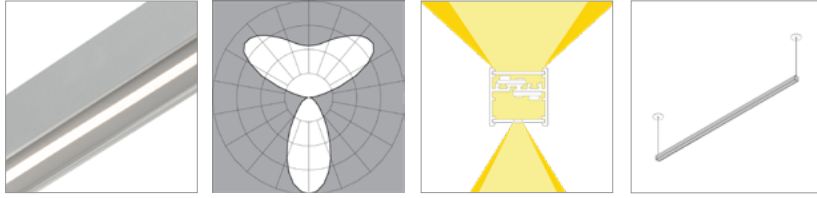

L90 >100,000 hours

90 CRI (90min., 96 avg.)

Low Output (LO)	2700K	3000K	3500K	4000K
Efficacy - Lumens per Watt	72	74	76	76
Lumens per foot (305mm)	513	529	540	545
Watts per foot (305mm)	7.2	7.2	7.2	7.2

Standard Output (SO)

Efficacy - Lumens per Watt	82	84	86	87
Lumens per foot (305mm)	1025	1058	1079	1090
Watts per foot (305mm)	12.7	12.7	12.7	12.7

High Output (HO)

Efficacy - Lumens per Watt	76	78	80	81
Lumens per foot (305mm)	1948	2010	2051	2071
Watts per foot (305mm)	25.8	25.8	25.8	25.8

Wide Batwing, up | 60° Symmetric, down, black finish (G1S2-BL)

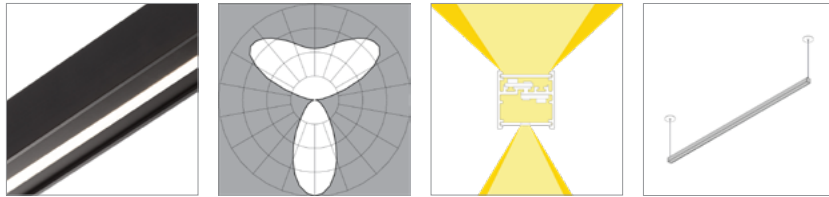

L90 >100,000 hours

90 CRI (90min., 96 avg.)

Low Output (LO)	2700K	3000K	3500K	4000K
Efficacy - Lumens per Watt	57	59	60	61
Lumens per foot (305mm)	409	422	431	435
Watts per foot (305mm)	7.2	7.2	7.2	7.2

Standard Output (SO)

Efficacy - Lumens per Watt	65	67	69	69
Lumens per foot (305mm)	818	844	861	870
Watts per foot (305mm)	12.7	12.7	12.7	12.7

High Output (HO)

Efficacy - Lumens per Watt	61	63	64	65
Lumens per foot (305mm)	1555	1604	1637	1653
Watts per foot (305mm)	25.8	25.8	25.8	25.8

Performance | Zipper Board Optics

Zipper Board Optics design has 72 diodes per foot (305mm).

Wide Batwing, up | 85° Asymmetric, down (G1A1)

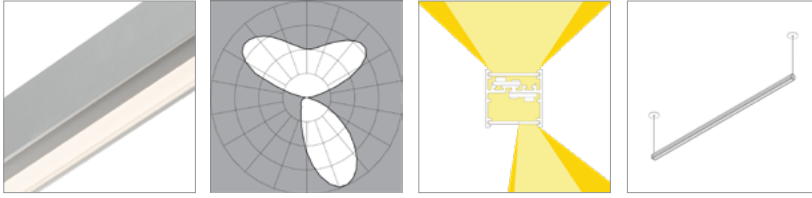

L90 >100,000 hours

90 CRI (90min., 96 avg.)

Low Output (LO)	2700K	3000K	3500K	4000K
Efficacy - Lumens per Watt	72	75	76	77
Lumens per foot (305mm)	517	534	545	550
Watts per foot (305mm)	7.2	7.2	7.2	7.2

Standard Output (SO)

Efficacy - Lumens per Watt	82	85	87	88
Lumens per foot (305mm)	1035	1067	1089	1100
Watts per foot (305mm)	12.7	12.7	12.6	12.7

High Output (HO)

Efficacy - Lumens per Watt	77	79	81	82
Lumens per foot (305mm)	1966	2028	2069	2090
Watts per foot (305mm)	25.8	25.8	25.8	25.8

Wide Batwing, up | 85° Aymmetric, down, black finish (G1A1-BL)

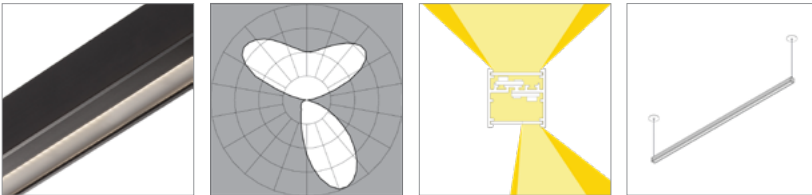

L90 >100,000 hours

90 CRI (90min., 96 avg.)

Low Output (LO)	2700K	3000K	3500K	4000K
Efficacy - Lumens per Watt	60	62	63	64
Lumens per foot (305mm)	429	443	452	456
Watts per foot (305mm)	7.2	7.2	7.2	7.2

Standard Output (SO)

Efficacy - Lumens per Watt	68	71	72	73
Lumens per foot (305mm)	858	885	903	912
Watts per foot (305mm)	12.7	12.7	12.7	12.7

High Output (HO)

Efficacy - Lumens per Watt	64	66	67	68
Lumens per foot (305mm)	1631	1682	1717	1734
Watts per foot (305mm)	25.8	25.8	25.8	25.8

Performance | Zipper Board Optics

Zipper Board Optics design has 72 diodes per foot (305mm).

Wide Batwing, up | 120° Flywing, down (G1G2)

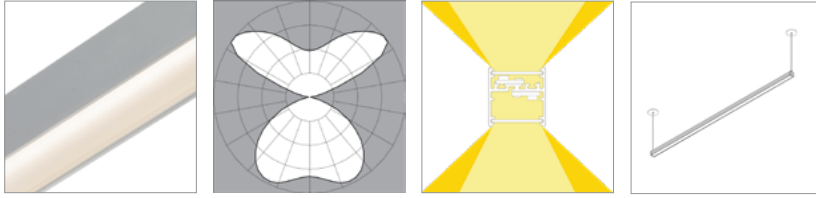

L90 >100,000 hours

90 CRI (90min., 96 avg.)

Low Output (LO)	2700K	3000K	3500K	4000K
Efficacy - Lumens per Watt	93	96	98	99
Lumens per foot (305mm)	669	690	704	711
Watts per foot (305mm)	7.2	7.2	7.2	7.2

Standard Output (SO)

Efficacy - Lumens per Watt	106	110	113	113
Lumens per foot (305mm)	1337	1379	1407	1421
Watts per foot (305mm)	12.7	12.7	12.6	12.7

High Output (HO)

Efficacy - Lumens per Watt	99	102	104	105
Lumens per foot (305mm)	2540	2621	2674	2701
Watts per foot (305mm)	25.8	25.8	25.8	25.8

Wide Batwing, up | 120° Flywing, down, black finish (G1G2-BL)

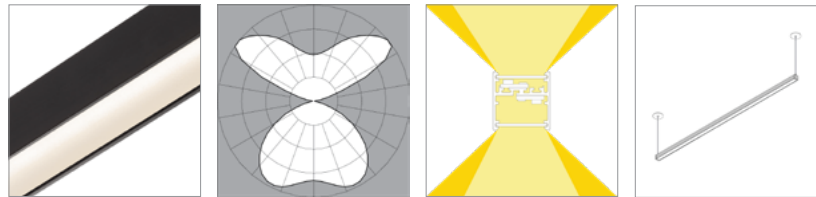

L90 >100,000 hours

90 CRI (90min., 96 avg.)

Low Output (LO)	2700K	3000K	3500K	4000K
Efficacy - Lumens per Watt	88	90	92	93
Lumens per foot (305mm)	626	646	659	666
Watts per foot (305mm)	7.2	7.2	7.2	7.2

Standard Output (SO)

Efficacy - Lumens per Watt	100	103	106	106
Lumens per foot (305mm)	1252	1292	1318	1331
Watts per foot (305mm)	12.7	12.7	12.6	12.7

High Output (HO)

Efficacy - Lumens per Watt	93	96	98	99
Lumens per foot (305mm)	2379	2455	2505	2530
Watts per foot (305mm)	25.8	25.8	25.8	25.8

Performance | Zipper Board Optics

Zipper Board Optics design has 72 diodes per foot (305mm).

Diffuse, down (D1)

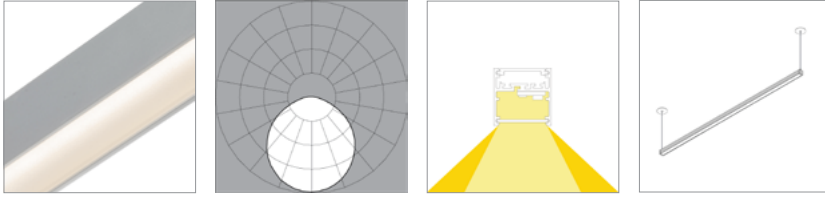

L90 >100,000 hours

90 CRI (90min., 96 avg.)

Low Output (LO)

	2700K	3000K	3500K	4000K
Efficacy - Lumens per Watt	65	67	68	69
Lumens per foot (305mm)	231	238	243	246
Watts per foot (305mm)	3.6	3.6	3.6	3.6

Standard Output (SO)

	2700K	3000K	3500K	4000K
Efficacy - Lumens per Watt	74	76	78	78
Lumens per foot (305mm)	462	477	487	491
Watts per foot (305mm)	6.4	6.4	6.4	6.4

High Output (HO)

	2700K	3000K	3500K	4000K
Efficacy - Lumens per Watt	69	71	72	73
Lumens per foot (305mm)	878	906	924	934
Watts per foot (305mm)	12.9	12.9	12.9	12.9

Diffuse, down, black finish (D1-BL)

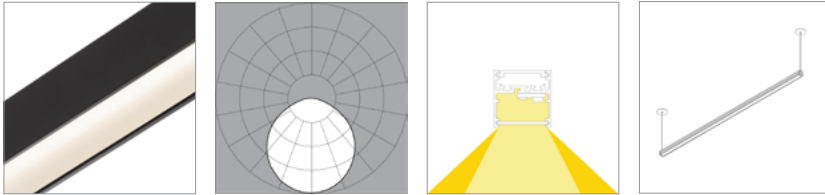

L90 >100,000 hours

90 CRI (90min., 96 avg.)

Low Output (LO)

	2700K	3000K	3500K	4000K
Efficacy - Lumens per Watt	50	52	53	54
Lumens per foot (305mm)	180	185	189	191
Watts per foot (305mm)	3.6	3.6	3.6	3.6

Standard Output (SO)

	2700K	3000K	3500K	4000K
Efficacy - Lumens per Watt	57	59	60	61
Lumens per foot (305mm)	359	371	378	382
Watts per foot (305mm)	6.4	6.4	6.4	6.4

High Output (HO)

	2700K	3000K	3500K	4000K
Efficacy - Lumens per Watt	53	55	56	57
Lumens per foot (305mm)	683	705	719	726
Watts per foot (305mm)	12.9	12.9	12.9	12.9

Performance | Zipper Board Optics

Zipper Board Optics design has 72 diodes per foot (305mm).

White Baffle, down (WB)

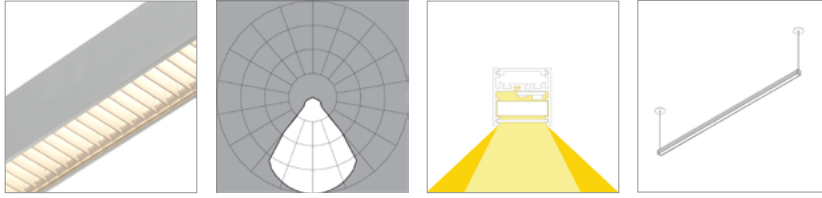

L90 >100,000 hours

	90 CRI (90min., 96 avg.)			
	2700K	3000K	3500K	4000K
Low Output (LO)				
Efficacy - Lumens per Watt	59	61	62	63
Lumens per foot (305mm)	212	218	223	225
Watts per foot (305mm)	3.6	3.6	3.6	3.6

Standard Output (SO)				
Efficacy - Lumens per Watt	68	70	71	72
Lumens per foot (305mm)	423	437	446	450
Watts per foot (305mm)	6.4	6.4	6.4	6.4

High Output (HO)				
Efficacy - Lumens per Watt	63	65	66	67
Lumens per foot (305mm)	805	830	847	855
Watts per foot (305mm)	12.9	12.9	12.9	12.9

White Baffle, down, black finish (WB-BL)

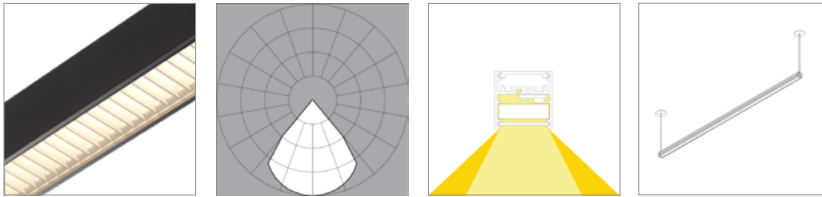

L90 >100,000 hours

	90 CRI (90min., 96 avg.)			
	2700K	3000K	3500K	4000K
Low Output (LO)				
Efficacy - Lumens per Watt	49	50	51	52
Lumens per foot (305mm)	173	179	182	184
Watts per foot (305mm)	3.6	3.6	3.6	3.6

Standard Output (SO)				
Efficacy - Lumens per Watt	55	57	58	59
Lumens per foot (305mm)	347	358	365	368
Watts per foot (305mm)	6.4	6.4	6.4	6.4

High Output (HO)				
Efficacy - Lumens per Watt	52	53	54	55
Lumens per foot (305mm)	659	679	693	700
Watts per foot (305mm)	12.9	12.9	12.9	12.9

Performance | Zipper Board Optics

Zipper Board Optics design has 72 diodes per foot (305mm).

Black Baffle, down (BB)

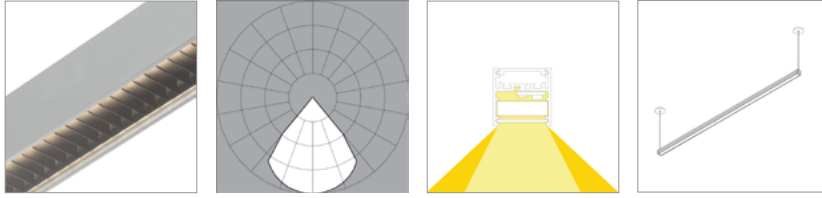

L90 >100,000 hours

Low Output (LO)	90 CRI (90min., 96 avg.)			
	2700K	3000K	3500K	4000K
Efficacy - Lumens per Watt	30	31	32	32
Lumens per foot (305mm)	107	111	113	114
Watts per foot (305mm)	3.6	3.6	3.6	3.6

Standard Output (SO)

Efficacy - Lumens per Watt	35	36	36	37
Lumens per foot (305mm)	215	222	226	228
Watts per foot (305mm)	6.4	6.4	6.4	6.4

High Output (HO)

Efficacy - Lumens per Watt	32	33	34	34
Lumens per foot (305mm)	408	421	430	434
Watts per foot (305mm)	12.9	12.9	12.9	12.9

Black Baffle, down, black finish (BB-BL)

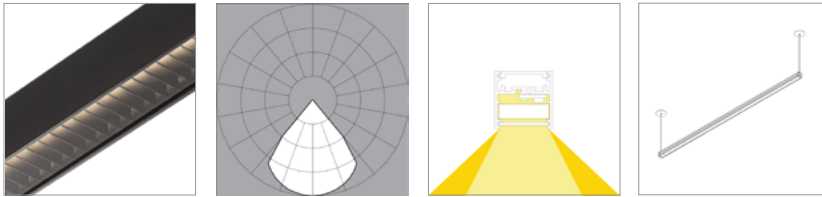

L90 >100,000 hours

Low Output (LO)	90 CRI (90min., 96 avg.)			
	2700K	3000K	3500K	4000K
Efficacy - Lumens per Watt	30	31	32	32
Lumens per foot (305mm)	107	111	113	114
Watts per foot (305mm)	3.6	3.6	3.6	3.6

Standard Output (SO)

Efficacy - Lumens per Watt	34	36	36	37
Lumens per foot (305mm)	215	221	226	228
Watts per foot (305mm)	6.4	6.4	6.4	6.4

High Output (HO)

Efficacy - Lumens per Watt	32	33	34	34
Lumens per foot (305mm)	408	420	429	433
Watts per foot (305mm)	12.9	12.9	12.9	12.9

Performance | Zipper Board Optics

Zipper Board Optics design has 72 diodes per foot (305mm).

40° Symmetric, down (S1)

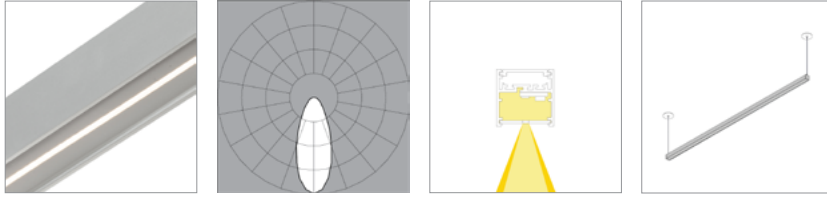

L90 >100,000 hours

	90 CRI (90min., 96 avg.)			
	2700K	3000K	3500K	4000K
Low Output (LO)				
Efficacy - Lumens per Watt	40	41	42	43
Lumens per foot (305mm)	143	147	150	152
Watts per foot (305mm)	3.6	3.6	3.6	3.6

Standard Output (SO)

Efficacy - Lumens per Watt	46	47	48	49
Lumens per foot (305mm)	285	294	301	304
Watts per foot (305mm)	6.4	6.4	6.4	6.4

High Output (HO)

Efficacy - Lumens per Watt	43	44	45	45
Lumens per foot (305mm)	542	560	571	577
Watts per foot (305mm)	12.9	12.9	12.9	12.9

40° Symmetric, down, black finish (S1-BL)

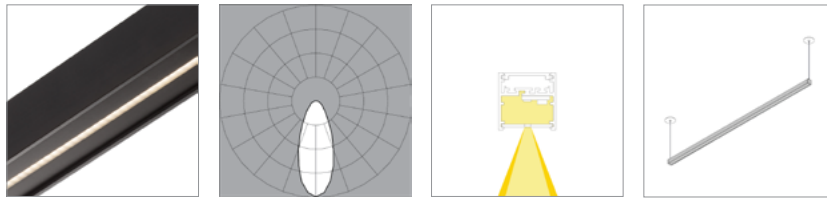

L90 >100,000 hours

	90 CRI (90min., 96 avg.)			
	2700K	3000K	3500K	4000K
Low Output (LO)				
Efficacy - Lumens per Watt	29	30	31	31
Lumens per foot (305mm)	103	106	109	110
Watts per foot (305mm)	3.6	3.6	3.6	3.6

Standard Output (SO)

Efficacy - Lumens per Watt	33	34	35	35
Lumens per foot (305mm)	206	213	217	219
Watts per foot (305mm)	6.4	6.4	6.4	6.4

High Output (HO)

Efficacy - Lumens per Watt	31	32	33	33
Lumens per foot (305mm)	392	405	413	417
Watts per foot (305mm)	12.9	12.9	12.9	12.9

Performance | Zipper Board Optics

Zipper Board Optics design has 72 diodes per foot (305mm).

60° Symmetric, down (S2)

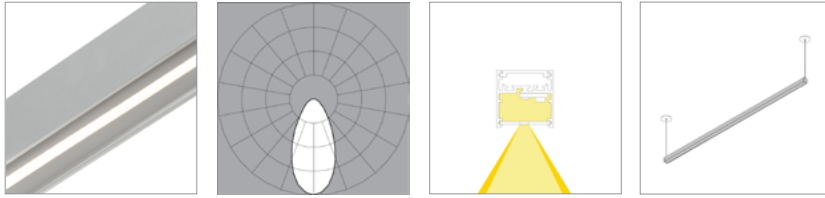

L90 >100,000 hours

Low Output (LO)	90 CRI (90min., 96 avg.)			
	2700K	3000K	3500K	4000K
Efficacy - Lumens per Watt	52	54	55	55
Lumens per foot (305mm)	185	191	195	197
Watts per foot (305mm)	3.6	3.6	3.6	3.6

Standard Output (SO)

Efficacy - Lumens per Watt	59	61	62	63
Lumens per foot (305mm)	371	383	391	394
Watts per foot (305mm)	6.4	6.4	6.4	6.4

High Output (HO)

Efficacy - Lumens per Watt	55	57	58	59
Lumens per foot (305mm)	705	727	742	749
Watts per foot (305mm)	12.9	12.9	12.9	12.9

60° Symmetric, down, black finish (S2-BL)

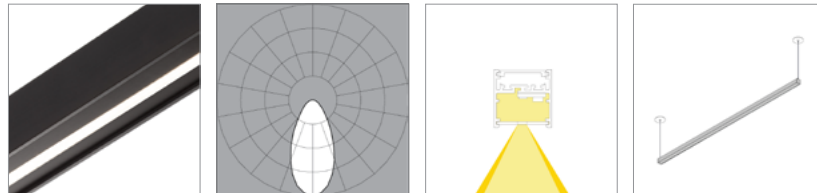

L90 >100,000 hours

Low Output (LO)	90 CRI (90min., 96 avg.)			
	2700K	3000K	3500K	4000K
Efficacy - Lumens per Watt	34	35	36	36
Lumens per foot (305mm)	121	125	128	129
Watts per foot (305mm)	3.6	3.6	3.6	3.6

Standard Output (SO)

Efficacy - Lumens per Watt	39	40	41	41
Lumens per foot (305mm)	242	250	255	258
Watts per foot (305mm)	6.4	6.4	6.4	6.4

High Output (HO)

Efficacy - Lumens per Watt	36	37	38	38
Lumens per foot (305mm)	461	475	485	490
Watts per foot (305mm)	12.9	12.9	12.9	12.9

Performance | Zipper Board Optics

Zipper Board Optics design has 72 diodes per foot (305mm).

85° Asymmetric, down (A1)

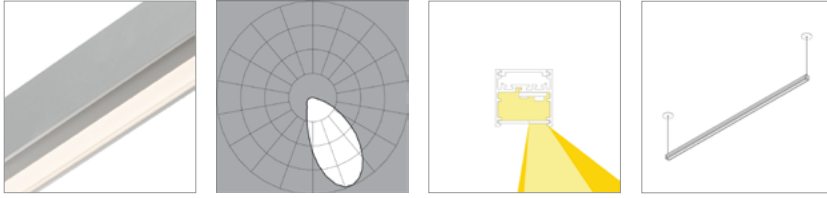

L90 >100,000 hours

	90 CRI (90min., 96 avg.)			
	2700K	3000K	3500K	4000K
Low Output (LO)				
Efficacy - Lumens per Watt	55	57	58	58
Lumens per foot (305mm)	196	202	206	208
Watts per foot (305mm)	3.6	3.6	3.6	3.6

Standard Output (SO)

Efficacy - Lumens per Watt	62	64	66	66
Lumens per foot (305mm)	391	404	412	416
Watts per foot (305mm)	6.4	6.4	6.4	6.4

High Output (HO)

Efficacy - Lumens per Watt	58	60	61	62
Lumens per foot (305mm)	743	767	782	790
Watts per foot (305mm)	12.9	12.9	12.9	12.9

85° Asymmetric, down, black finish (A1-BL)

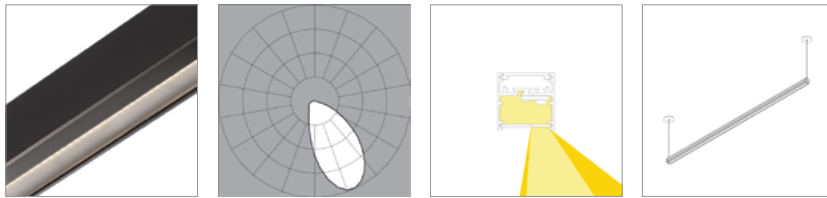

L80 >60,000 hours

	90 CRI (90min., 96 avg.)			
	2700K	3000K	3500K	4000K
Low Output (LO)				
Efficacy - Lumens per Watt	40	41	42	43
Lumens per foot (305mm)	142	147	150	151
Watts per foot (305mm)	3.6	3.6	3.6	3.6

Standard Output (SO)

Efficacy - Lumens per Watt	46	47	48	48
Lumens per foot (305mm)	285	294	300	303
Watts per foot (305mm)	6.4	6.4	6.4	6.4

High Output (HO)

Efficacy - Lumens per Watt	42	44	45	45
Lumens per foot (305mm)	541	558	569	575
Watts per foot (305mm)	12.9	12.9	12.9	12.9

Performance | Zipper Board Optics

Zipper Board Optics design has 72 diodes per foot (305mm).

120° Flying, down (G2)

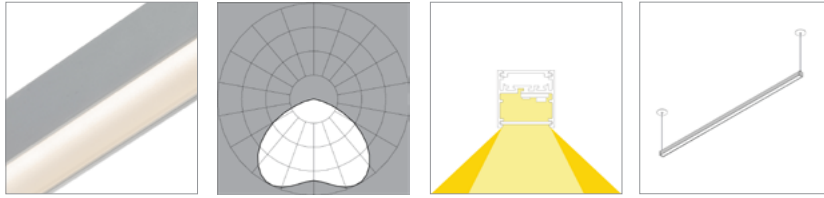

L90 >100,000 hours

	90 CRI (90min., 96 avg.)			
	2700K	3000K	3500K	4000K
Low Output (LO)				
Efficacy - Lumens per Watt	95	98	100	101
Lumens per foot (305mm)	341	351	359	362
Watts per foot (305mm)	3.6	3.6	3.6	3.6

Standard Output (SO)				
Efficacy - Lumens per Watt	108	112	114	115
Lumens per foot (305mm)	681	703	717	724
Watts per foot (305mm)	6.4	6.4	6.4	6.4

High Output (HO)				
Efficacy - Lumens per Watt	101	104	106	107
Lumens per foot (305mm)	1294	1335	1363	1376
Watts per foot (305mm)	12.9	12.9	12.9	12.9

120° Flying, down, black finish (G2-BL)

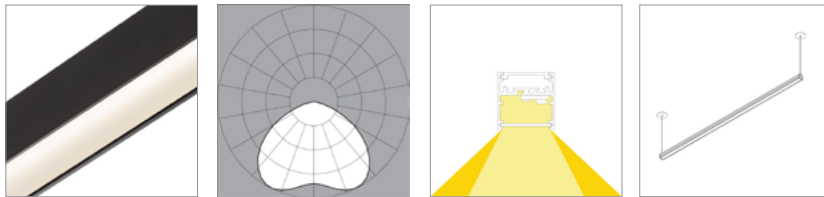

L90 >100,000 hours

	90 CRI (90min., 96 avg.)			
	2700K	3000K	3500K	4000K
Low Output (LO)				
Efficacy - Lumens per Watt	93	96	98	99
Lumens per foot (305mm)	332	342	349	353
Watts per foot (305mm)	3.6	3.6	3.6	3.6

Standard Output (SO)				
Efficacy - Lumens per Watt	106	109	111	112
Lumens per foot (305mm)	663	684	698	705
Watts per foot (305mm)	6.4	6.4	6.4	6.4

High Output (HO)				
Efficacy - Lumens per Watt	98	101	103	104
Lumens per foot (305mm)	1261	1300	1327	1340
Watts per foot (305mm)	12.9	12.9	12.9	12.9

Performance | Zipper Board Optics

Zipper Board Optics design has 72 diodes per foot (305mm).

Wide Batwing, up (G1)

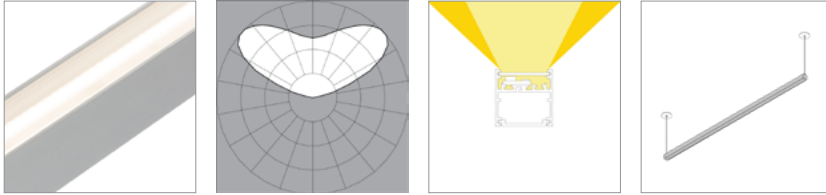

L90 >100,000 hours

	90 CRI (90min., 96 avg.)			
	2700K	3000K	3500K	4000K
Low Output (LO)				
Efficacy - Lumens per Watt	90	92	94	95
Lumens per foot (305mm)	320	330	337	340
Watts per foot (305mm)	3.6	3.6	3.6	3.6

Standard Output (SO)

Efficacy - Lumens per Watt	102	105	107	108
Lumens per foot (305mm)	640	661	674	681
Watts per foot (305mm)	6.4	6.4	6.4	6.4

High Output (HO)

Efficacy - Lumens per Watt	95	98	100	101
Lumens per foot (305mm)	1217	1255	1281	1293
Watts per foot (305mm)	12.9	12.9	12.9	12.9

Wide Batwing, up, black finish (G1-BL)

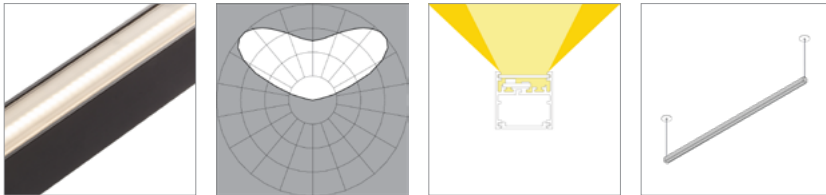

L90 >100,000 hours

	90 CRI (90min., 96 avg.)			
	2700K	3000K	3500K	4000K
Low Output (LO)				
Efficacy - Lumens per Watt	80	83	84	85
Lumens per foot (305mm)	287	296	302	305
Watts per foot (305mm)	3.6	3.6	3.6	3.6

Standard Output (SO)

Efficacy - Lumens per Watt	91	94	96	97
Lumens per foot (305mm)	574	592	604	610
Watts per foot (305mm)	6.4	6.4	6.4	6.4

High Output (HO)

Efficacy - Lumens per Watt	85	88	89	90
Lumens per foot (305mm)	1090	1124	1147	1159
Watts per foot (305mm)	12.9	12.9	12.9	12.9

Copyright © 2025 Vode Lighting LLC. All rights reserved. Vode, the Vode logo, BoxRail, FlyWing, MicroBaffle, Button Board, Zipper Board, Zero Canopy, Zero Block, VodeNODE and other names are either registered trademarks or trademarks of Vode Lighting LLC in the United States and may be registered in other countries. All other trademarks listed herein belong to their respective owners. Due to ongoing innovation, specification details may change without notice.