



Spec Guide

BoxRail® | Surface Mount | 907



Accent, ambient or task lighting for wall or ceiling wash, grazing, cove or reveal accent.



BoxRail: Button Board

Benefits & Features

Minimal, Robust Design

Square profile, 1.14 in x 1.14 in.

Superior Light Quality & Performance

Output up to 1367 lm/ft (HO), 120 lm/W (HO). 90 CRI static & tunable white 2200K - 5000K. Custom ranges available upon request.

Adaptive Mounting System

Fixed and rotatable options for wall, surface, perimeter slot and cove.

Static White Light for Any Application

Seamless cove and perimeter lighting in four standard color temperatures.



85° Black Asymmetric



Rotating Bracket

Build Your Specification

907-BX				»
---------------	--	--	--	---

System & Rail Type	System Length	Rail Length	Mounting	Power Location
907-BX BoxRail	Specify overall system length in ft/in or M/mm.	24 24" (610mm) 36 36" (914mm) 48 48" (1219mm) 60 60" (1524mm) 72 72" (1829mm) ZZ Other rail length or layout (please specify)	F1S Fixed 1 R1B Rotate 1 R2S Rotate 2	Remote Power RP10 10' (3.048m) Wire Harness RP25 25' (7.62m) Wire Harness RP50 50' (15.24m) Wire Harness RP75 75' (22.86m) Wire Harness RP100 100' (30.48m) Wire Harness
See Rail Length Chart for more details. ⚠ Custom lengths may result in light gaps on the fixture. See Rail Length Chart for more details.				

				»
--	--	--	--	---

Power Type	Voltage	Emergency Power	LED Type	Lumen Output
Flexible 1 to 1 Power	1 120V 2 120V - 277V X Not Yet Specified	0 No Emergency Power ZZ Emergency Power (specify requirements)	Z Zipper Board B Button Board ³	LO Low Output SO Standard Output HO High Output ZZ Other (please specify)
AE 0-10V, 1.0% Dimming AT 0-10V, 0.1% Dimming AD DALI, 0.1% Dimming AX DMX, 100-0% Dimming AH Hi-lume 1% EcoSystem, Soft On / Fade to Black Technology, LDE ¹ AH2 ELV 1% 2-wire (Forward and Reverse Phase)				See IES Files page for details. See Power Guide for driver features & limitations.
Optimized Power Add 'O' to power type example: AEO, ATO...etc. ¹ VodeNODE Add 'N' to power type for Flexible 1 to 1 Power Add 'ON' to power type for Optimized Power example: AEN, ATN, AEON, ADON...etc. ²				
ZZ Other (please specify) See Power Guide for driver features & limitations.				

				»
--	--	--	--	---

Color Temperature	Optics	Sensors	Finish	Options
90+ CRI 27 2700K 30 3000K 35 3500K 40 4000K ZZ Tunable White Available See Guide for details	Zipper Board (Z) 1 Diffuse WB White Baffle BB Black Baffle G1 120° Batwing G2 120° FlyWing S1 40° Symmetric S2 60° Symmetric A1 85° Asymmetric Button Board (B) 19 19° x 48° Oval 36 36° Medium	0 None ZZ Sensor (specify requirements)	AL Clear Anodized WH White Painted BL Black Anodized ZZ Other (please specify)	0 None ZZ Other (please specify)

NOTES & LIMITATIONS

¹ Optimized Power is not available with Hi-lume 1% EcoSystem (AHO) Power Type.

² VodeNODE enclosure is not available with ELV 1% 2-wire (AH2) Power Type.

³ Button Board (B) is not available in 90 CRI.

Contact factory for Chicago Plenum.

Standard 5 Year Limited Warranty. See details [here](#). Contact factory for options on Limited Warranties up to 20 years.

Listed to UL standards for damp location by a Nationally Recognized Testing Laboratory (NRTL) recognized by OSHA. Certain limitations exist for each Certification. Contact factory for verification.



Applications

General Interior and Open Office



Wesley Mission, Sydney



Wesley Mission, Sydney

Applications

Cove

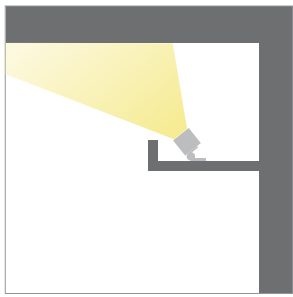

Ideal for office, retail, hospitality, museum and residential.

Slot

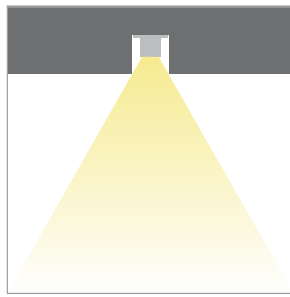

Ideal for office, institutional, retail and hospitality.

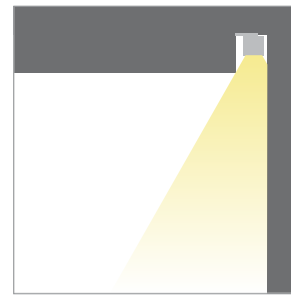

Ideal for lobby, retail, hospitality and institutional.

Surface

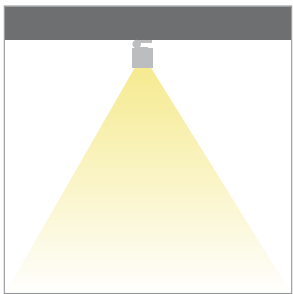

Ideal for retail, hospitality, museum and residential.

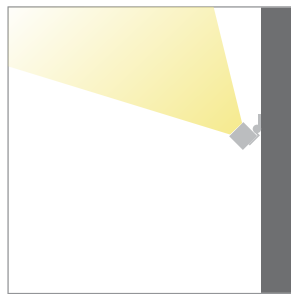

Ideal for retail, hospitality, museum and residential.

Cove, Perimeter Slot, Wall Graze, and Flood

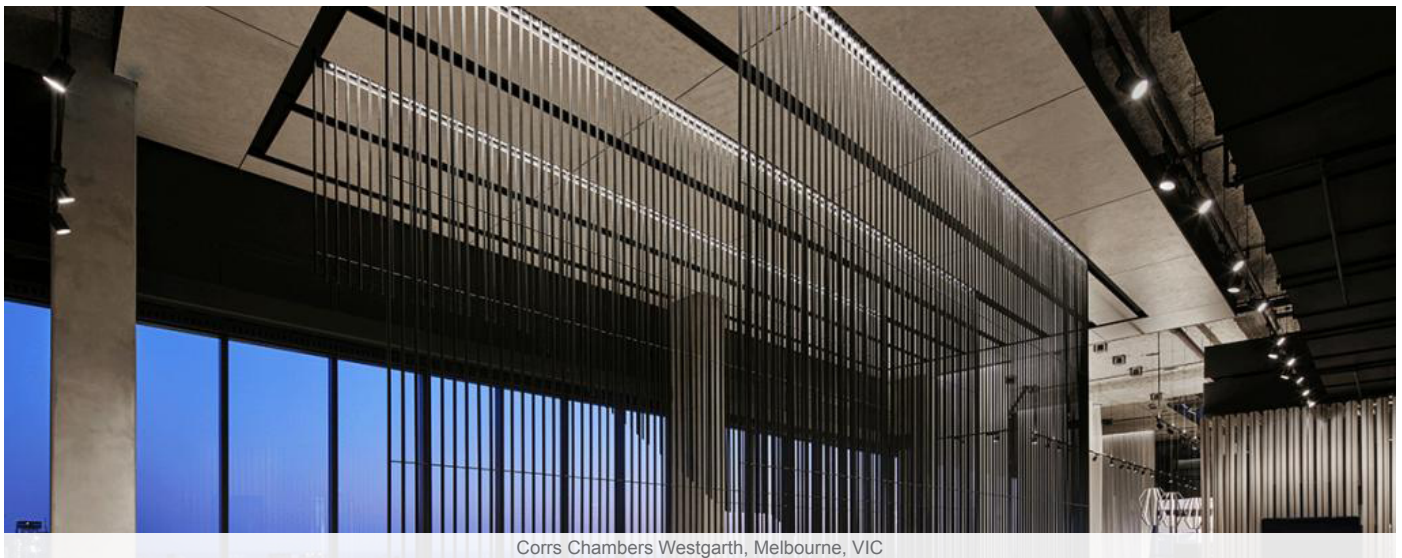

Corrs Chambers Westgarth, Melbourne, VIC

Applications

Cove, Perimeter Slot, Wall Graze, and Flood



The Fairmont, Washington, DC

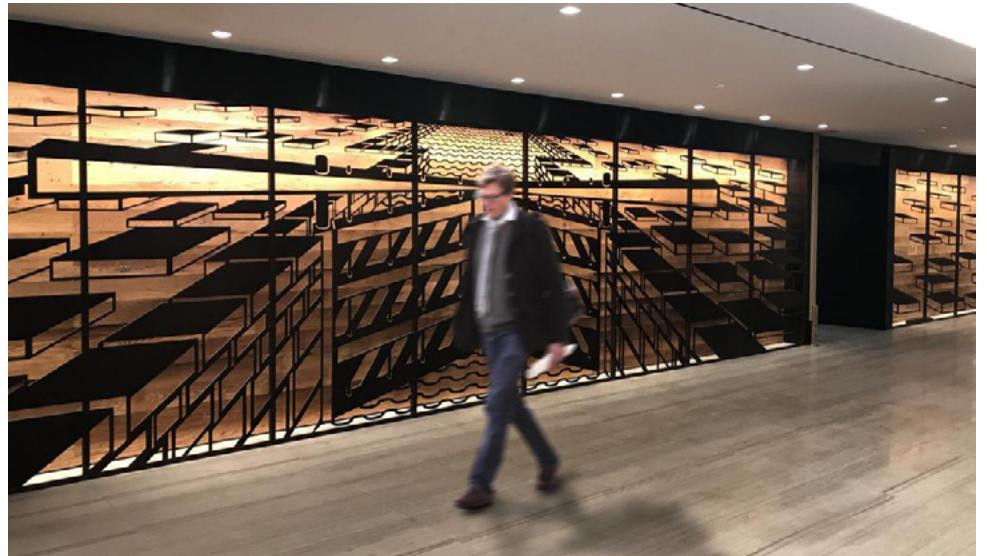

The Foundry, Washington, DC



Corrs Chambers Westgarth, Melbourne, VIC

Declare Label

All Vode Lighting linear light fixtures proudly carry the Red List Approved designation.

See [International Living Future Institute](#) website for details.



Declare.

Vode Adaptive Architectural Lighting Systems

Vode Lighting LLC

Final Assembly: Sonoma, California, US
Life Expectancy: 10+ Year(s)
End of Life Options: Recyclable (100%)

Ingredients:

Anodized Aluminum (6063-T5 Alloy); Steel; Small Electrical Component (RoHS)¹; Copper; **Fluorinated Ethylene Propylene (masterbatch)**²; Polymethyl methacrylate (PMMA); Stainless Steel; Polyoxymethylene Copolymer (POM); Styrene-butadiene polymer, hydrogenated; Poly(methyl methacrylate/butyl acrylate/styrene) (PMMA/BA/S); Styrene/butadiene copolymer; Distillates; Polypropylene; Calcium carbonate; Polycarbonate; EVA Copolymer; Methyl methacrylate (MMA); Polyphenylene Oxide; Brass; Tin, Organic

¹LBC Temp Exception RL-002 - Small Electrical Components
²LBC Temp Exception RL-023 - Wire Sheathing Subject to NFPA 90A, NFPA 262, UL® 910

Living Building Challenge Criteria: Compliant

I-13 Red List:

<input type="checkbox"/> LBC Red List Free	% Disclosed: 100% at 100ppm
<input checked="" type="checkbox"/> LBC Red List Approved	VOC Content: Not Applicable
<input type="checkbox"/> Declared	

I-10 Interior Performance: Not Applicable
I-14 Responsible Sourcing: Not Applicable

VDE-0001
 EXP. 01 JAN 2025
 Original Issue Date: 2018

MANUFACTURER RESPONSIBLE FOR LABEL ACCURACY
 INTERNATIONAL LIVING FUTURE INSTITUTE™ living-future.org/declare



Structure

Rail Lengths	24" (610mm) - 72" (1828mm). Modified lengths available. See Rail Length Chart for more details.
Rail Dimensions	1.14" (29mm) x 1.14" (29mm) x length.
Construction	Extruded and machined 6063 aluminum.
System Run Length	24" (610mm) minimum. Unlimited maximum.
Operating Temperature	32°F to 104°F (0°C to 40°C).
Humidity	0-85%, non-condensing.
Weight	0.65lbs per ft (0.29kg per 305mm). Power supply and housing not included.

Materials

LED Board Construction	Aluminum core PCB, black LCP connectors, RoHS compliant.
Lens	High-impact extruded acrylic glass (PMMA).
Baffle	6063 aluminum, RoHS compliant painted finish.
Button Optics	High-impact cast acrylic glass (PMMA), polycarbonate (PC) holder.
Power Cable	Ø4mm, 18/2 AWG, Plenum (CMP) rated semi-rigid PVC or FEP, flame tested UL-910 (<i>PVC free in 2020</i>)
Cable Connectors	Unfilled black nylon, rated UL 94 V-0, halogen free, PVC or FEP overmold, RoHS compliant (<i>PVC free in 2020</i>)
Remote Linear Power Housing (RLP)	20.7" x 2.375" x 2.53", 0.054" formed Galvanized Steel
Remote Brick Power Housing (RBP)	4.32" x 3.37" x .078" Galvanized Steel mounting plate

Dimensions

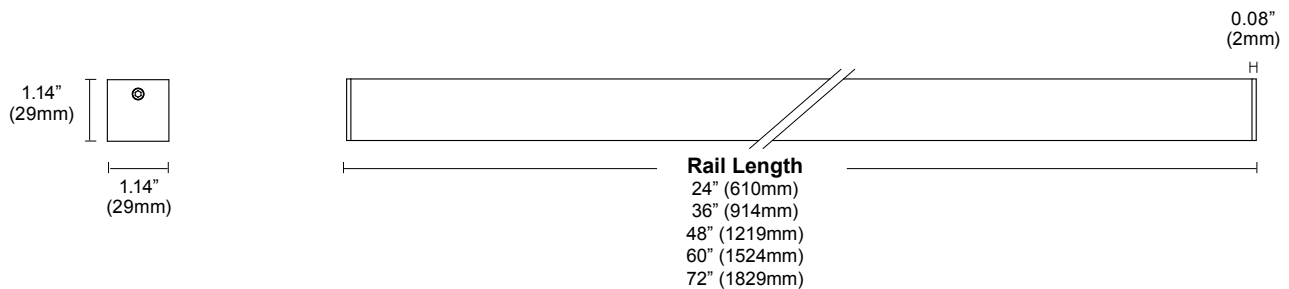

Mounting Options

Fixed 1

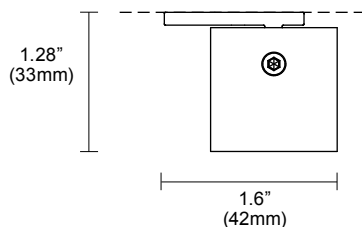

Installation	1.6" (42mm) is required for bracket installation.
Power Feed	Located on side, 3" (75mm) from one end of the fixture.

Rotate 1

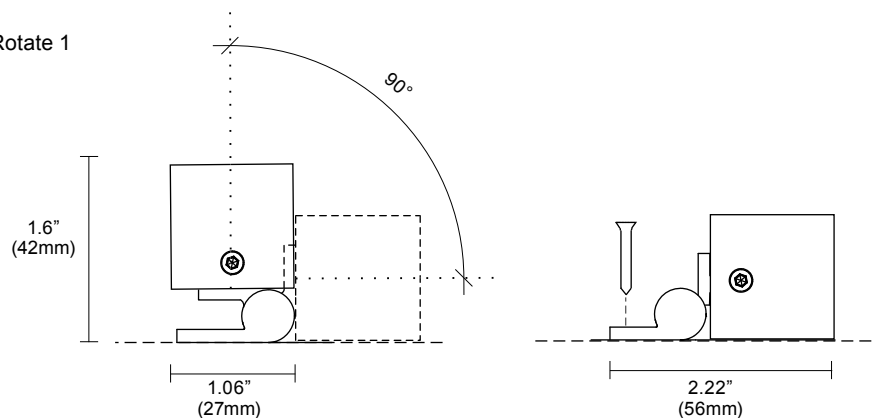

Installation	Allow 2.5" (64mm) on the mounting surface for installation.
Power Feed	Located on bottom, 3" (75mm) from one end of the fixture.
Bracket Rotation	Rotates 90°. May be locked in any position.

Mounting Options Continued

Rotate 2

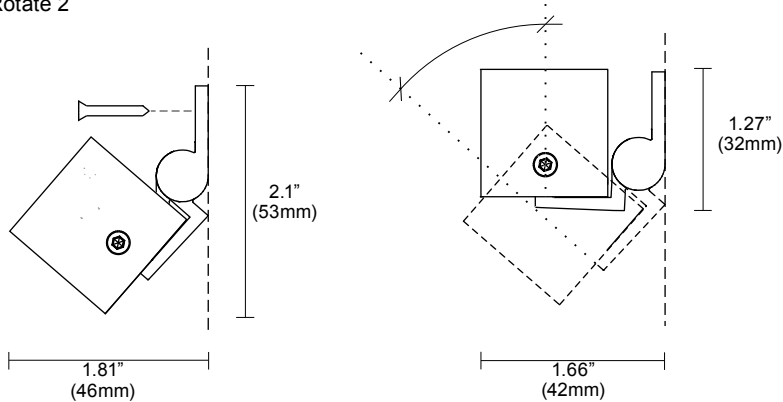

Installation	Allow 2.5" (64mm) on the mounting surface for installation.
Power Feed	Located on side, 3" (75mm) from one end of the fixture.
Bracket Rotation	Rotates 48°. May be locked in any position.

Power and Controls

Power Type	Class 2 (<60V output) constant current driver
Dimming Controls	Dimming (0.1%, 1%), 0-10V, DALI, DMX, Hi-lume 1% are available. See Power Guide for details.
Input Voltage	120V - 277V, 50/60hz
Power Location	Remote power. Maximum remote distance up to 100' (30.5m) depending on driver selection. See Power Guide for details.

Remote power is locating the power supply away from the fixture. Remote power comes in two housing styles: brick style and linear style. Consult [Power Guide](#) to determine which type you will receive.

Remote Brick Power Housing

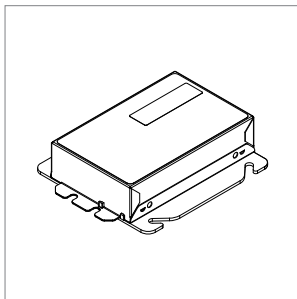

Supplied for some remote power applications. One remote power supply housing is supplied for each rail. Provided driver mounting plate fits standard 4" metal, square J-Boxes with a minimum volume of 21 in³ (J-Box not provided). See [Tech Sheet](#) for details.

Remote Linear Power Housing

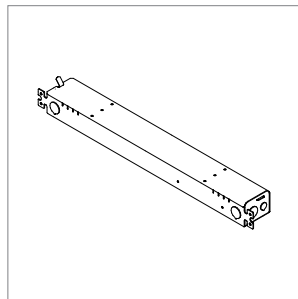

One remote power supply housing is supplied with each power supply. All Vode linear remote drivers come in a 0.054" (0.8mm) formed galvanized steel power supply housing with five (5) knockouts: (4) 1-1/8", (1) 7/8" and (1) 9/16". Accommodates standard linear power supplies. See [Tech Sheet](#) for details.

Wire Harness

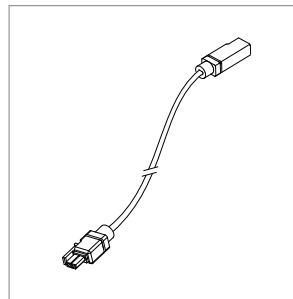

Wire harness connects driver to rail section. Lengths of 10' (3.0m) & 25' (7.6m) with snap-lock connectors for quick and easy installation. Multiple harnesses may be combined for lengths up to 100' (30.5m). See [Tech Sheet](#) for details.

Power and Controls

Flexible 1 to 1 power

For Flexible 1 to 1 Power, Vode supplies one single output driver per fixture, allowing each fixture to be controlled independently. Direct/Indirect fixtures are supplied with two single output drivers, allowing the direct and indirect lighting to be controlled independently. Consult [Power Guide](#) to determine which type you will receive.

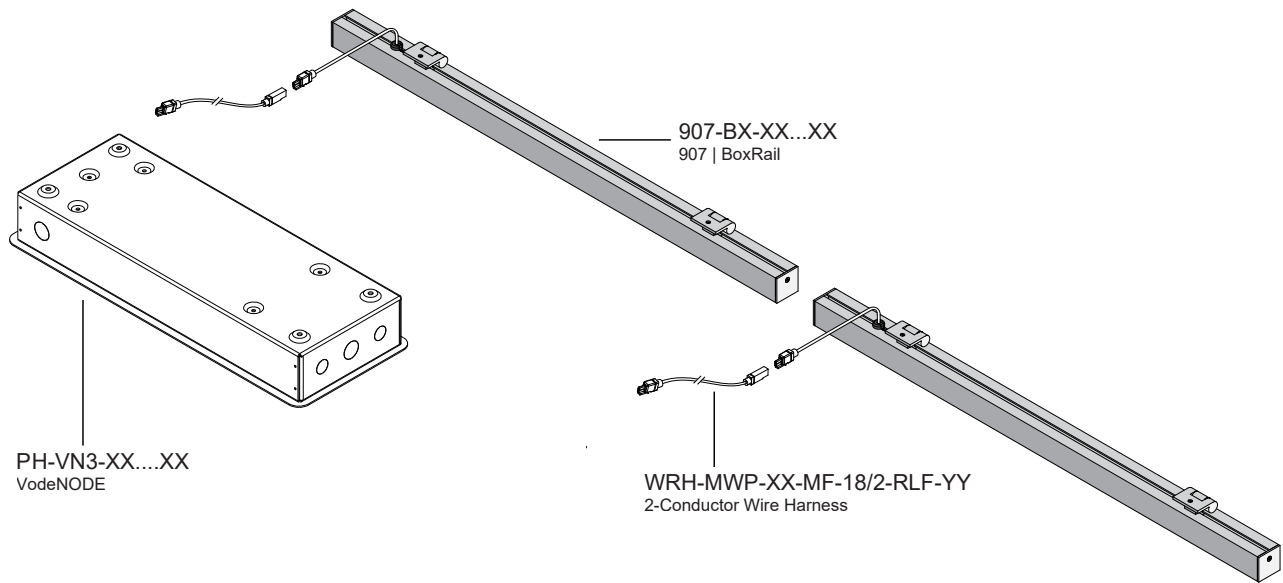

Optimized Power

To optimize power, Vode configures specifications with drivers that have 2 or 4 outputs. Depending on system configurations and power requirements, up to 4 fixtures can be powered from a 4-output driver. Consult [Power Guide](#) to determine which type you will receive.

IMPORTANT: Each fixture will still require individual wire harnesses, as shown below.

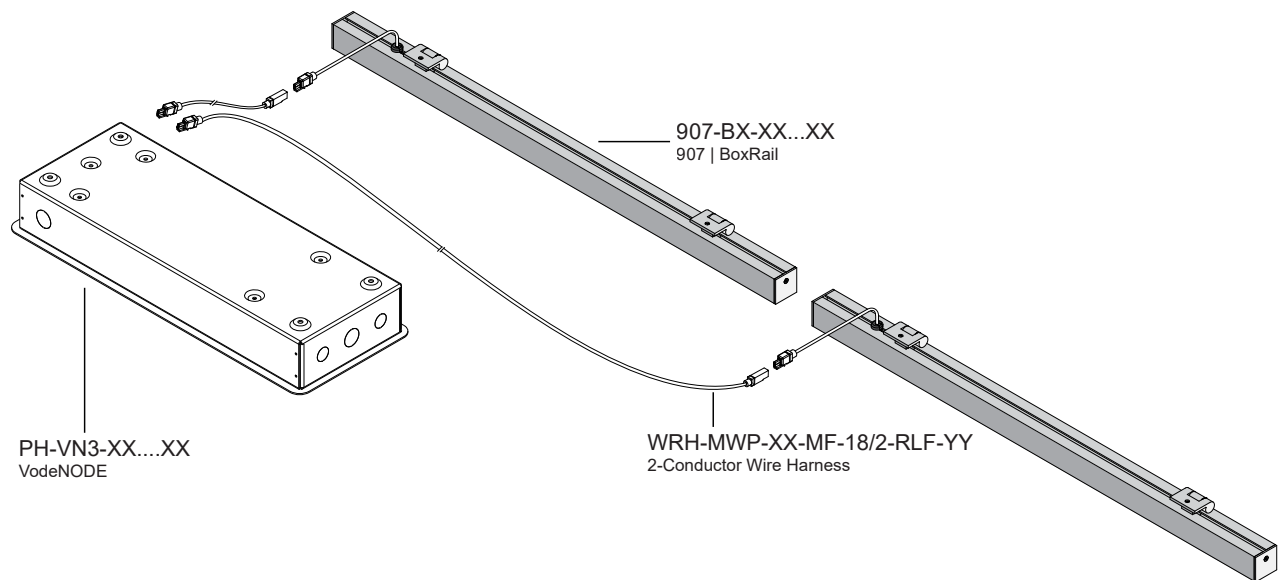

Note: Drawings not to scale, for reference only.

Performance | Zipper Board Optics

Zipper Board Optics design has 72 diodes per foot (305mm).

Diffuse (1)

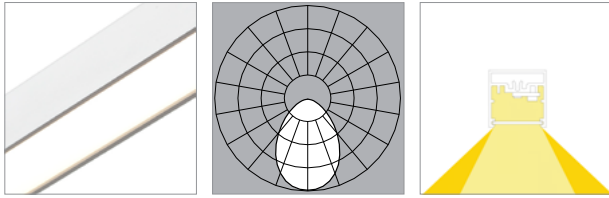

L80 >60,000 hours

90 CRI (90min., 96 avg.)

Low Output (LO)	2700K	3000K	3500K	4000K
Efficacy - Lumens per Watt	66	68	69	71
Lumens per foot (305mm)	244	252	257	262
Watts per foot (305mm)	3.8	3.8	3.8	3.8

Standard Output (SO)

Efficacy - Lumens per Watt	82	84	86	88
Lumens per foot (305mm)	489	504	515	525
Watts per foot (305mm)	6.1	6.1	6.1	6.1

High Output (HO)

Efficacy - Lumens per Watt	76	78	80	82
Lumens per foot (305mm)	929	958	978	997
Watts per foot (305mm)	12.4	12.4	12.4	12.4

White Baffle (WB)

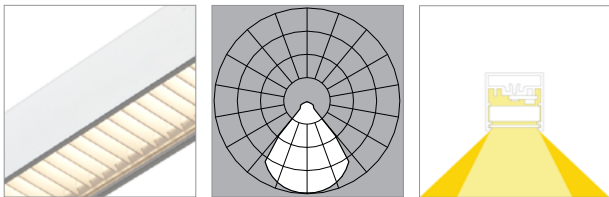

L80 >60,000 hours

90 CRI (90min., 96 avg.)

Low Output (LO)	2700K	3000K	3500K	4000K
Efficacy - Lumens per Watt	44	47	47	48
Lumens per foot (305mm)	164	173	173	177
Watts per foot (305mm)	3.8	3.8	3.8	3.8

Standard Output (SO)

Efficacy - Lumens per Watt	55	57	58	59
Lumens per foot (305mm)	329	339	346	353
Watts per foot (305mm)	6.1	6.1	6.1	6.1

High Output (HO)

Efficacy - Lumens per Watt	51	53	54	55
Lumens per foot (305mm)	625	644	658	671
Watts per foot (305mm)	12.4	12.4	12.4	12.4

Performance | Zipper Board Optics

Zipper Board Optics design has 72 diodes per foot (305mm).

Black Baffle (BB)

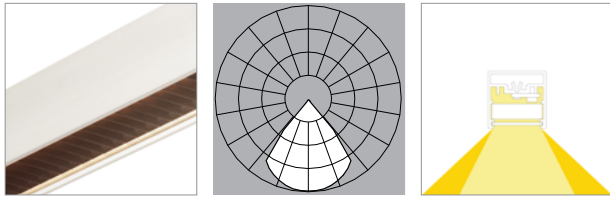

L80 >60,000 hours

90 CRI (90min., 96 avg.)

Low Output (LO)	2700K	3000K	3500K	4000K
Efficacy - Lumens per Watt	25	26	26	26
Lumens per foot (305mm)	90	95	95	97
Watts per foot (305mm)	3.8	3.8	3.8	3.8

Standard Output (SO)

Efficacy - Lumens per Watt	30	31	32	33
Lumens per foot (305mm)	180	186	190	194
Watts per foot (305mm)	6.1	6.1	6.1	6.1

High Output (HO)

Efficacy - Lumens per Watt	28	29	30	30
Lumens per foot (305mm)	343	353	361	368
Watts per foot (305mm)	12.4	12.4	12.4	12.4

120° Batwing (G1)

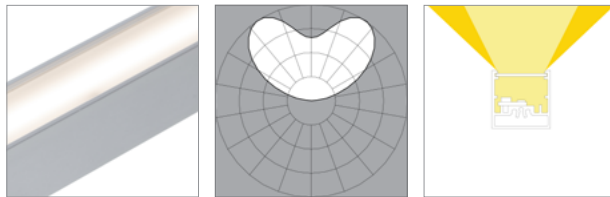

L80 >60,000 hours

90 CRI (90min., 96 avg.)

Low Output (LO)	2700K	3000K	3500K	4000K
Efficacy - Lumens per Watt	84	87	89	91
Lumens per foot (305mm)	314	323	330	337
Watts per foot (305mm)	3.8	3.8	3.8	3.8

Standard Output (SO)

Efficacy - Lumens per Watt	105	109	111	113
Lumens per foot (305mm)	627	647	660	673
Watts per foot (305mm)	6.1	6.1	6.1	6.1

High Output (HO)

Efficacy - Lumens per Watt	97	100	102	104
Lumens per foot (305mm)	1192	1229	1254	1279
Watts per foot (305mm)	12.4	12.4	12.4	12.4

Performance | Zipper Board Optics

Zipper Board Optics design has 72 diodes per foot (305mm).

120° FlyWing (G2)

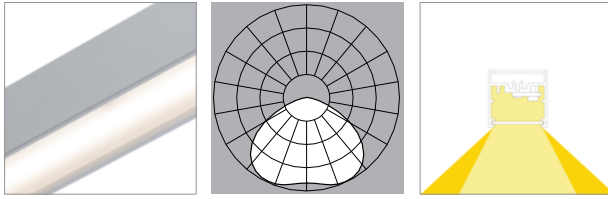

L80 >60,000 hours

90 CRI (90min., 96 avg.)

Low Output (LO)	2700K	3000K	3500K	4000K
Efficacy - Lumens per Watt	78	80	82	83
Lumens per foot (305mm)	289	298	304	310
Watts per foot (305mm)	3.8	3.8	3.8	3.8

Standard Output (SO)

Efficacy - Lumens per Watt	96	99	101	103
Lumens per foot (305mm)	578	596	608	620
Watts per foot (305mm)	6.1	6.1	6.1	6.1

High Output (HO)

Efficacy - Lumens per Watt	90	93	94	96
Lumens per foot (305mm)	1098	1132	1155	1178
Watts per foot (305mm)	12.4	12.4	12.4	12.4

40° Symmetric (S1)

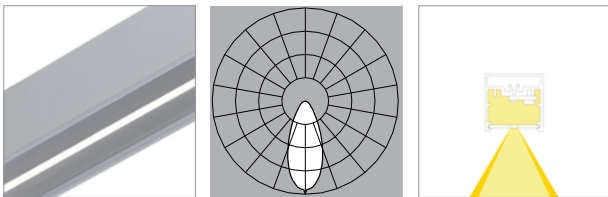

L80 >60,000 hours

90 CRI (90min., 96 avg.)

Low Output (LO)	2700K	3000K	3500K	4000K
Efficacy - Lumens per Watt	36	37	38	39
Lumens per foot (305mm)	133	137	140	142
Watts per foot (305mm)	3.8	3.8	3.8	3.8

Standard Output (SO)

Efficacy - Lumens per Watt	45	46	47	48
Lumens per foot (305mm)	265	273	279	285
Watts per foot (305mm)	6.1	6.1	6.1	6.1

High Output (HO)

Efficacy - Lumens per Watt	41	43	44	44
Lumens per foot (305mm)	504	520	530	541
Watts per foot (305mm)	12.4	12.4	12.4	12.4

Performance | Zipper Board Optics

Zipper Board Optics design has 72 diodes per foot (305mm).

60° Symmetric (S2)

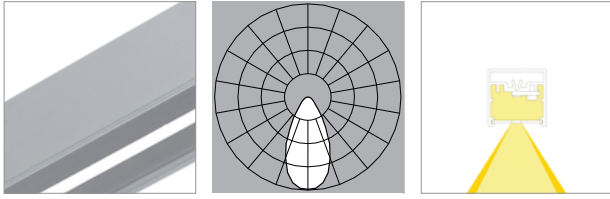

L80 >60,000 hours

90 CRI (90min., 96 avg.)

Low Output (LO)	2700K	3000K	3500K	4000K
Efficacy - Lumens per Watt	45	46	47	48
Lumens per foot (305mm)	165	170	173	177
Watts per foot (305mm)	3.8	3.8	3.8	3.8

Standard Output (SO)

Efficacy - Lumens per Watt	55	57	58	59
Lumens per foot (305mm)	329	340	347	354
Watts per foot (305mm)	6.1	6.1	6.1	6.1

High Output (HO)

Efficacy - Lumens per Watt	51	53	54	55
Lumens per foot (305mm)	626	646	659	672
Watts per foot (305mm)	12.4	12.4	12.4	12.4

85° Asymmetric (A1)

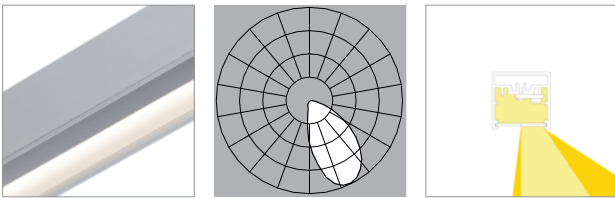

L80 >60,000 hours

90 CRI (90min., 96 avg.)

Low Output (LO)	2700K	3000K	3500K	4000K
Efficacy - Lumens per Watt	57	59	60	61
Lumens per foot (305mm)	210	217	221	226
Watts per foot (305mm)	3.8	3.8	3.8	3.8

Standard Output (SO)

Efficacy - Lumens per Watt	65	67	68	69
Lumens per foot (305mm)	420	434	443	451
Watts per foot (305mm)	6.6	6.6	6.6	6.6
CRI	-	-	-	-

High Output (HO)

Efficacy - Lumens per Watt	65	67	69	70
Lumens per foot (305mm)	799	824	841	858
Watts per foot (305mm)	12.4	12.4	12.4	12.4

Performance | Zipper Board Optics

Zipper Board Optics design has 72 diodes per foot (305mm).

40° Symmetric, black finish (S1-BL)

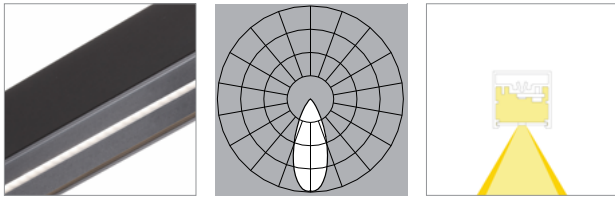

L80 >60,000 hours

Low Output (LO)	90 CRI (90min., 96 avg.)			
	2700K	3000K	3500K	4000K
Efficacy - Lumens per Watt	28	29	29	30
Lumens per foot (305mm)	101	104	106	108
Watts per foot (305mm)	3.8	3.8	3.8	3.8

Standard Output (SO)	2700K	3000K	3500K	4000K
Efficacy - Lumens per Watt	34	35	36	37
Lumens per foot (305mm)	202	208	213	217
Watts per foot (305mm)	6.1	6.1	6.1	6.1

High Output (HO)	2700K	3000K	3500K	4000K
Efficacy - Lumens per Watt	32	33	33	34
Lumens per foot (305mm)	384	396	404	412
Watts per foot (305mm)	12.4	12.4	12.4	12.4

60° Symmetric, black finish (S2-BL)

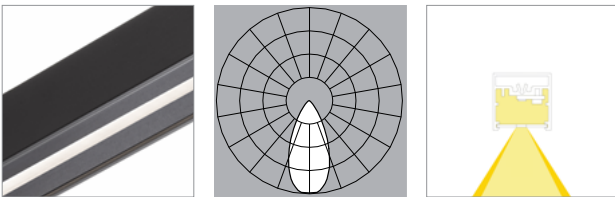

L80 >60,000 hours

Low Output (LO)	90 CRI (90min., 96 avg.)			
	2700K	3000K	3500K	4000K
Efficacy - Lumens per Watt	33	34	35	36
Lumens per foot (305mm)	123	127	129	132
Watts per foot (305mm)	3.8	3.8	3.8	3.8

Standard Output (SO)	2700K	3000K	3500K	4000K
Efficacy - Lumens per Watt	41	43	43	44
Lumens per foot (305mm)	245	253	258	263
Watts per foot (305mm)	6.1	6.1	6.1	6.1

High Output (HO)	2700K	3000K	3500K	4000K
Efficacy - Lumens per Watt	38	40	40	41
Lumens per foot (305mm)	446	481	491	501
Watts per foot (305mm)	12.4	12.4	12.4	12.4

Performance | Button Board Optics

Button Board Optics design has 72 diodes per foot (305mm).

85° Asymmetric, black finish (A1-BL)

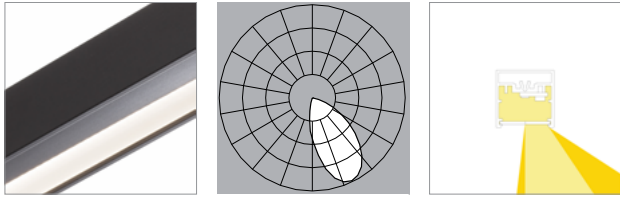

L80 >60,000 hours

90 CRI (90min., 96 avg.)

	2700K	3000K	3500K	4000K
Low Output (LO)				
Efficacy - Lumens per Watt	30	31	32	32
Lumens per foot (305mm)	110	114	116	118
Watts per foot (305mm)	3.8	3.8	3.8	3.8
Standard Output (SO)				
Efficacy - Lumens per Watt	37	38	39	40
Lumens per foot (305mm)	220	227	232	236
Watts per foot (305mm)	6.1	6.1	6.1	6.1
High Output (HO)				
Efficacy - Lumens per Watt	34	36	36	37
Lumens per foot (305mm)	418	431	440	449
Watts per foot (305mm)	12.4	12.4	12.4	12.4

Performance | Button Board Optics

Button Board Optics design has 72 diodes per foot (305mm).

19° x 48° Oval (19)

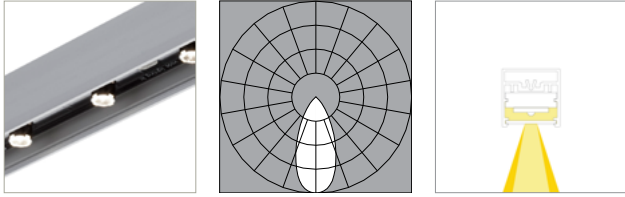

L80 >70,000 hours

Standard Output (SO)	80 CRI (80min., 84 avg.)			
	2700K	3000K	3500K	4000K
Efficacy - Lumens per Watt	61	64	67	69
Lumens per foot (305mm)	423	441	460	478
Watts per foot (305mm)	6.9	6.9	6.9	6.9

High Output (HO)

Efficacy - Lumens per Watt	55	57	60	62
Lumens per foot (305mm)	648	673	701	729
Watts per foot (305mm)	11.7	11.7	11.7	11.7
	-	-	83	-

36° Medium (36)

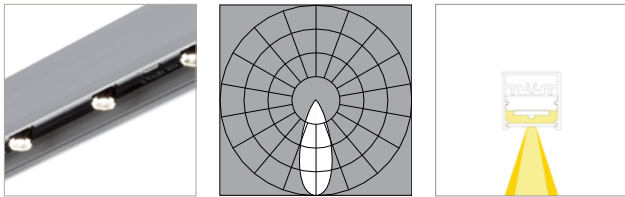

L80 >70,000 hours

Standard Output (SO)	80 CRI (80min., 84 avg.)			
	2700K	3000K	3500K	4000K
Efficacy - Lumens per Watt	71	74	78	80
Lumens per foot (305mm)	492	513	534	556
Watts per foot (305mm)	6.9	6.9	6.9	6.9

High Output (HO)

Efficacy - Lumens per Watt	64	66	70	72
Lumens per foot (305mm)	747	778	810	843
Watts per foot (305mm)	11.7	11.7	11.7	11.7

Copyright © 2025 Vode Lighting LLC. All rights reserved. Vode, the Vode logo, BoxRail, FlyWing, MicroBaffle, Button Board, Zipper Board, Zero Canopy, Zero Block, VodeNODE and other names are either registered trademarks or trademarks of Vode Lighting LLC in the United States and may be registered in other countries. All other trademarks listed herein belong to their respective owners. Due to ongoing innovation, specification details may change without notice.