

Spec Guide

ZipTwo | Round 3515 | Ceiling Cable | 707



Direct lighting for open office and ambient applications.



Round 3515, Diffuse, white

Benefits & Features

Low Profile Design

Round profile. 1.38" (35mm) x 0.60" (15mm).

Superior Light Quality with High Diffusion

Output up to 1308 lm/ft (4290 lm/m) (HO), 134 lm/W HO. 90 CRI & tunable white (2200K-5000K) available.

Adaptive Power Body

Full range dimming power for all protocols. Integral or remote power available. Remote power available up to 100' (30.5m) away.

High Diffusion & Uniform Distribution

Wide, soft distribution without diode image.

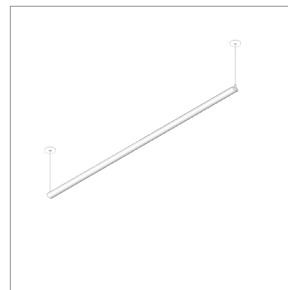

Small Round Canopy



Integral Power

Build Your Specification

707-Z2	S			CC	»
--------	---	--	--	----	---

System & Rail Type	System Type	System Length	Rail Length	Mounting	Arm/Cord Length
707-Z2 ZipTwo	S Suspended	Specify overall system length in ft/in or M/mm. <i>Corner and Shapes Available See Guide for details.</i>	24 24" (610mm) 36 36" (914mm) 48 48" (1219mm) 60 60" (1524mm) 72 72" (1829mm) 96 96" (2438mm) 108 108" (2743 mm) 120 120" (3048 mm) 132 132" (3352 mm) 144 144" (3658 mm) ZZ Other rail length or layout (please specify)	CC Ceiling Cable	48 48" cord (1219mm) 96 96" cord (2438mm) ZZ Other (please specify)

See [Rail Length Chart](#) for more details.

Custom lengths may result in light gaps on the fixture. See [Rail Length Chart](#) for more details.

»			»
---	--	--	---

Power Location	Power Type	Voltage	Emergency Power
Integral Power	Flexible 1 to 1 Power	1 120V	0 No Emergency Power
IP Integral Power	AE 0-10V, 1.0% Dimming	2 120V - 277V	ZZ Emergency Power (specify requirements)
Remote Power	AT 0-10V, 0.1% Dimming	X Not Yet Specified	
Specify mounting and harness length code example: 2R25, 2R50 ...etc.	AD DALI, 0.1% Dimming		
Mounting Option	AX DMX, 100-0% Dimming		
2R Small Round Canopy	AH Hi-lume 1% EcoSystem, Soft On / Fade to Black Technology, LDE ¹		
4R Large Round Canopy	AH2 ELV 1% 2-wire (Forward and Reverse Phase)		
Wire Harness	Optimized Power		
10 10' (3.048m) Wire Harness	Add 'O' to power type example: AEO, ATO...etc. ¹		
25 25' (7.62m) Wire Harness	VodeNODE		
50 50' (15.24m) Wire Harness	Add 'N' to power type for Flexible 1 to 1 Power		
75 75' (22.86m) Wire Harness	Add 'ON' to power type for Optimized Power example: AEN, ATN, AEON, ADON...etc. ²		
100 100' (30.48m) Wire Harness	ZZ Other (please specify)		

See [Power Guide](#) for driver features & limitations.

»	Z		S4	
---	---	--	----	--

LED Type	Lumen Output	Color Temperature	Optics	Sensors ³
Z Zipper Board	LO Low Output SO Standard Output HO High Output ZZ Other (please specify) See IES Files page for details. See Power Guide for driver features & limitations.	90+ CRI 27 2700K 30 3000K 35 3500K 40 4000K ZZ Tunable White Available See Guide for details.	S4 Round 3515, Diffuse	0 None ENC Canopy with integrated Enlighted Micro Sensor WSC Canopy with integrated Legrand Wattstopper sensor LAC Canopy with integrated Lutron Athena sensor ZZ Other (please specify)

»	WH
---	----

Finish	Options
WH White	0 None 9 9' 18/3 Cord and Plug CP Chicago Plenum LLLC Luminaire Level Lighting Controls

NOTES & LIMITATIONS

¹ Optimized Power is not available with Hi-lume 1% EcoSystem (AHO) Power Type.

² VodeNODE enclosure is not available with ELV 1% 2-wire (AH2) Power Type.

³ Sensors, drivers and control units that are integrated into Vode fixtures are discrete components that communicate with network lighting controls. For more information about each network lighting control system, visit the manufacturer's website for additional system information and technical data sheets.

For general information about network lighting controls, consult the DesignLights Consortium® (DLC) [Networked Lighting Control Qualified Product List](#).

Standard 5 Year Limited Warranty. See details [here](#). Contact factory for options on Limited Warranties up to 20 years.

Listed to UL standards for damp location by a Nationally Recognized Testing Laboratory (NRTL) recognized by OSHA. Certain limitations exist for each Certification. Contact factory for verification.



Applications

General Interior and Open Office



Round 3515, Diffuse



Round 3515, Diffuse

Declare Label

All Vode Lighting linear light fixtures proudly carry the Red List Approved designation.

See [International Living Future Institute](https://www.livingfuture.org) website for details.



Vode Adaptive Architectural Lighting Systems

Vode Lighting LLC

Final Assembly: Sonoma, California, US
Life Expectancy: 10+ Year(s)
End of Life Options: Recyclable (100%)

Ingredients:

Anodized Aluminum (6063-T5 Alloy); Steel; Small Electrical Component (RoHS)¹; Copper; **Fluorinated Ethylene Propylene (masterbatch)**²; Polymethyl methacrylate (PMMA); Stainless Steel; Polyoxymethylene Copolymer (POM); Styrene-butadiene polymer, hydrogenated; Poly(methyl methacrylate/butyl acrylate/styrene) (PMMA/BA/S); Styrene/butadiene copolymer; Distillates; Polypropylene; Calcium carbonate; Polycarbonate; EVA Copolymer; Methyl methacrylate (MMA); Polyphenylene Oxide; Brass; Tin, Organic

¹LBC Temp Exception RL-002 - Small Electrical Components
²LBC Temp Exception RL-023 - Wire Sheathing Subject to NFPA 90A, NFPA 262, UL® 910

Living Building Challenge Criteria: Compliant

I-13 Red List:

<input type="checkbox"/> LBC Red List Free	% Disclosed: 100% at 100ppm
<input checked="" type="checkbox"/> LBC Red List Approved	VOC Content: Not Applicable
<input type="checkbox"/> Declared	

I-10 Interior Performance: Not Applicable
I-14 Responsible Sourcing: Not Applicable

VDE-0001
 EXP. 01 JAN 2025
 Original Issue Date: 2018

MANUFACTURER RESPONSIBLE FOR LABEL ACCURACY
 INTERNATIONAL LIVING FUTURE INSTITUTE™ [living-future.org/declare](https://www.living-future.org/declare)



Structure

Rail Lengths	24" (610mm) - 144" (3658mm). Modified lengths available. See Rail Length Chart for more details.
Rail Dimensions	1.38" (35mm) x 1.29" (33mm) x length.
Construction	Extruded and machined 6063 aluminum.
Mounting	Ceiling mount to jbox or driver housing.
Cable Length	48" (1220mm) and 96" (2438mm) available. Field adjustable. Non-standard cable lengths available.
System Run Length	24" (610mm) minimum. Unlimited maximum.
Operating Temperature	32°F to 104°F (0°C to 40°C).
Humidity	0-85%, non-condensing.
System Weight	0.35 lbs per foot (0.16 kg per 305mm) Power supply and housing not included.

Materials

LED Board Construction	Aluminum core PCB, black LCP connectors, RoHS compliant.
Lens	High-impact extruded acrylic glass (PMMA).
Suspension Cable	Ø4mm, 22/4 AWG, TPE jacket, FEP-insulated, Red List Approved.
Power Cable	Ø3mm, 33/2 AWG, Plenum (CMP) rated semi-rigid PVC or FEP, flame tested UL-910, Red List Approved.
Cable Connectors	Unfilled black nylon, rated UL 94 V-0, halogen free, PVC or FEP overmold, RoHS compliant, Red List Approved.
Remote Linear Power Housing	20.7" x 2.375" x 2.53", 0.054" formed Galvanized Steel.
Remote Brick Power Housing	4.32" x 3.37" x .078" Galvanized Steel mounting plate.
Integral Power Housing	extruded and machined 6063 aluminum.
Center Cable Suspension	3/64" aircraft cable.

Mounting Options

Remote Power

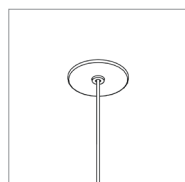

Small Round Canopy
Ø2.5" (51mm)

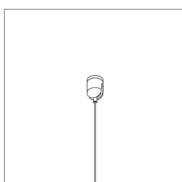

Center Support Cable
108" - 144" Rails Only
Center Support Cable for mounting to T-Bar tile available.

Integral Power (24"-72")

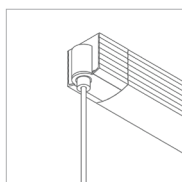

Integral Power (end)
h 1.8" (46mm)
w 1.7" (43mm)

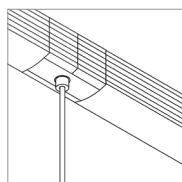

Integral Power (joint)

Dimensions

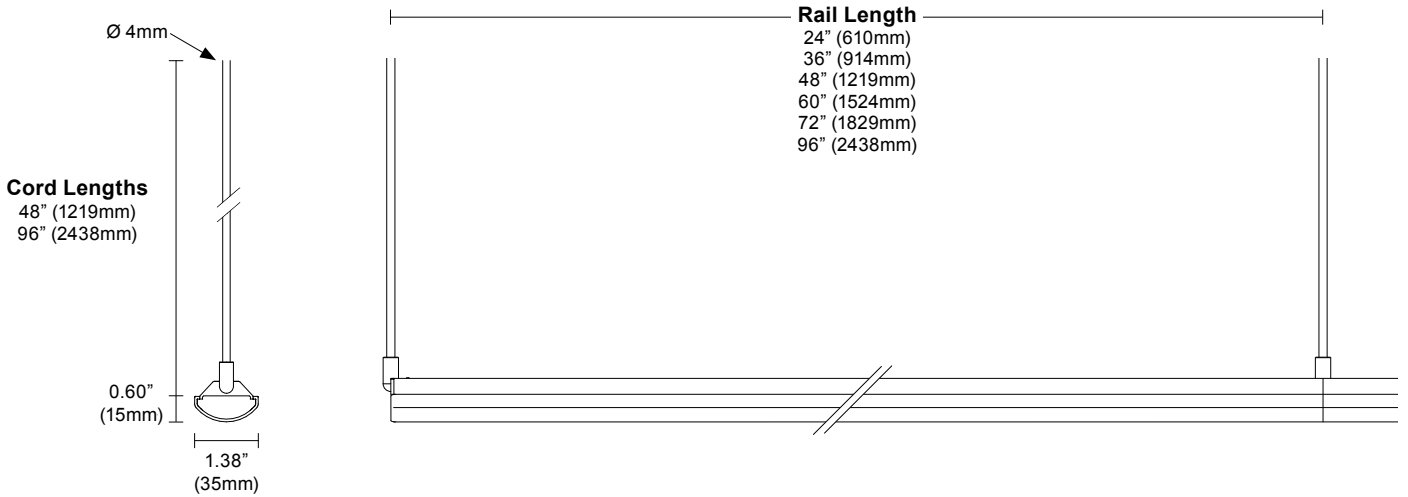

Layout

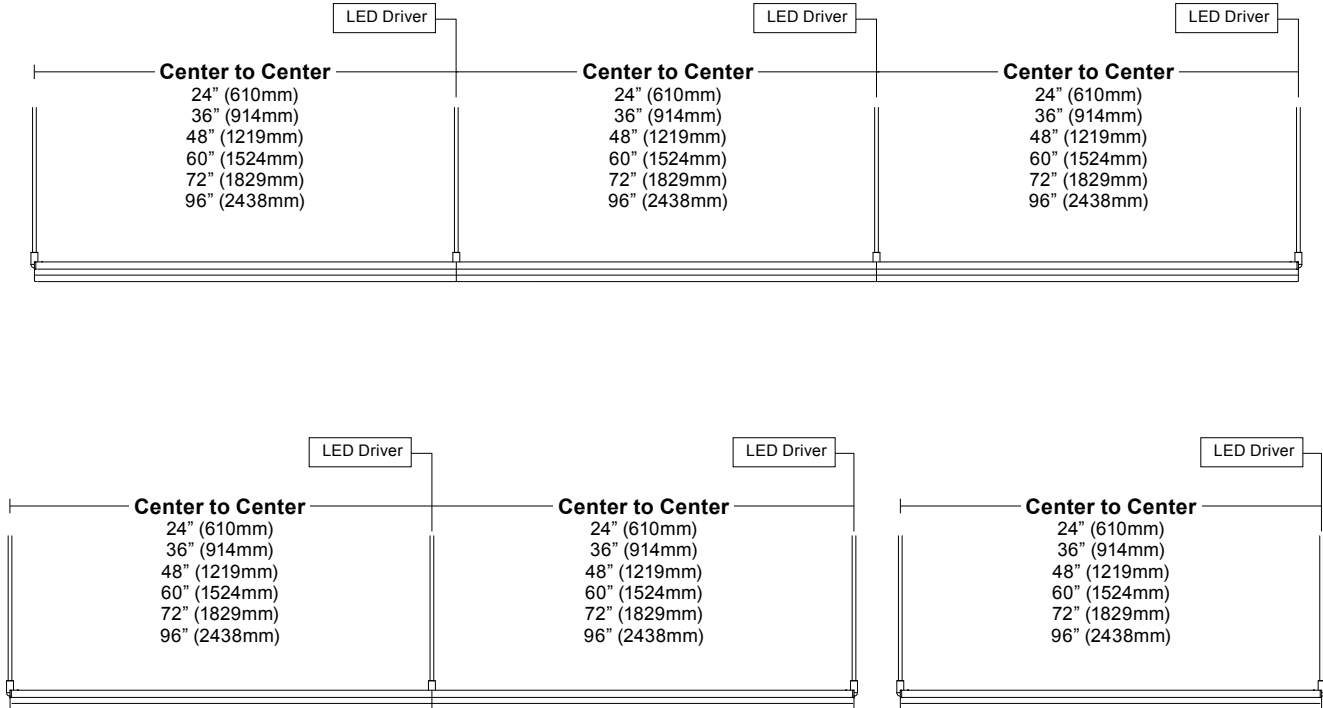

Corner and Shapes Available (Square, Rectangle, L-Shape, U-Shape, ZigZag) [See Guide](#) for details.

Dimensions

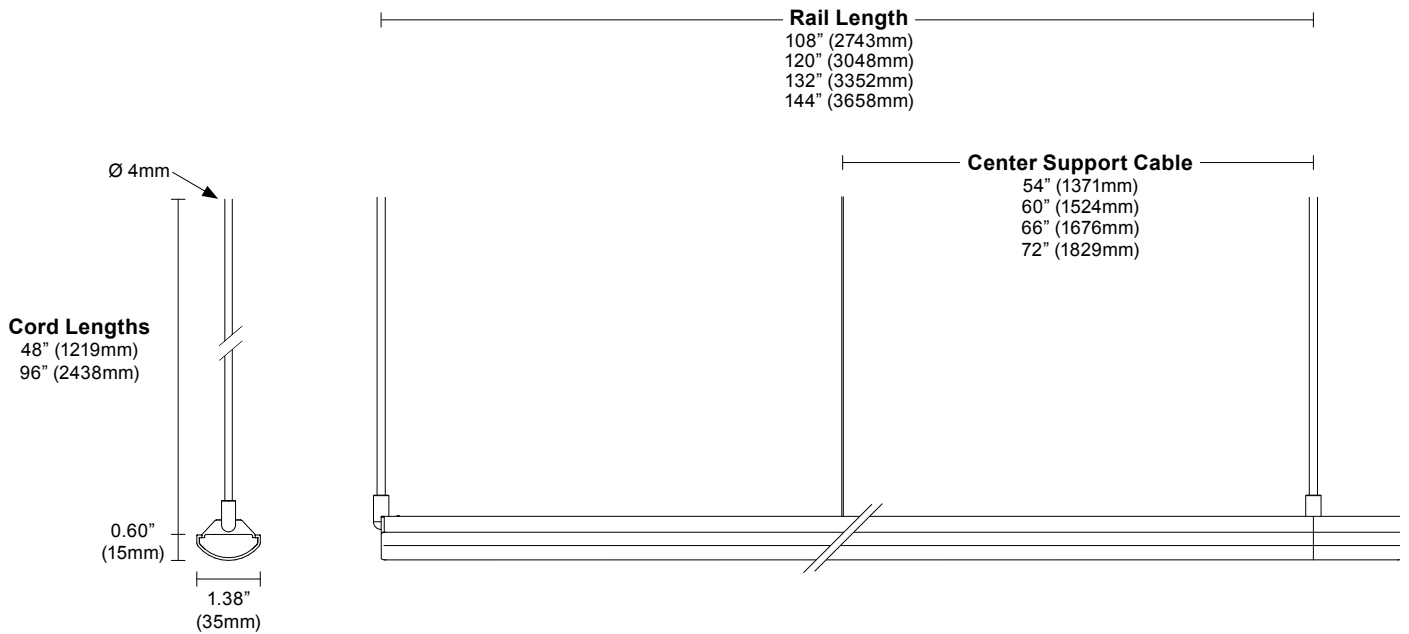

Layout

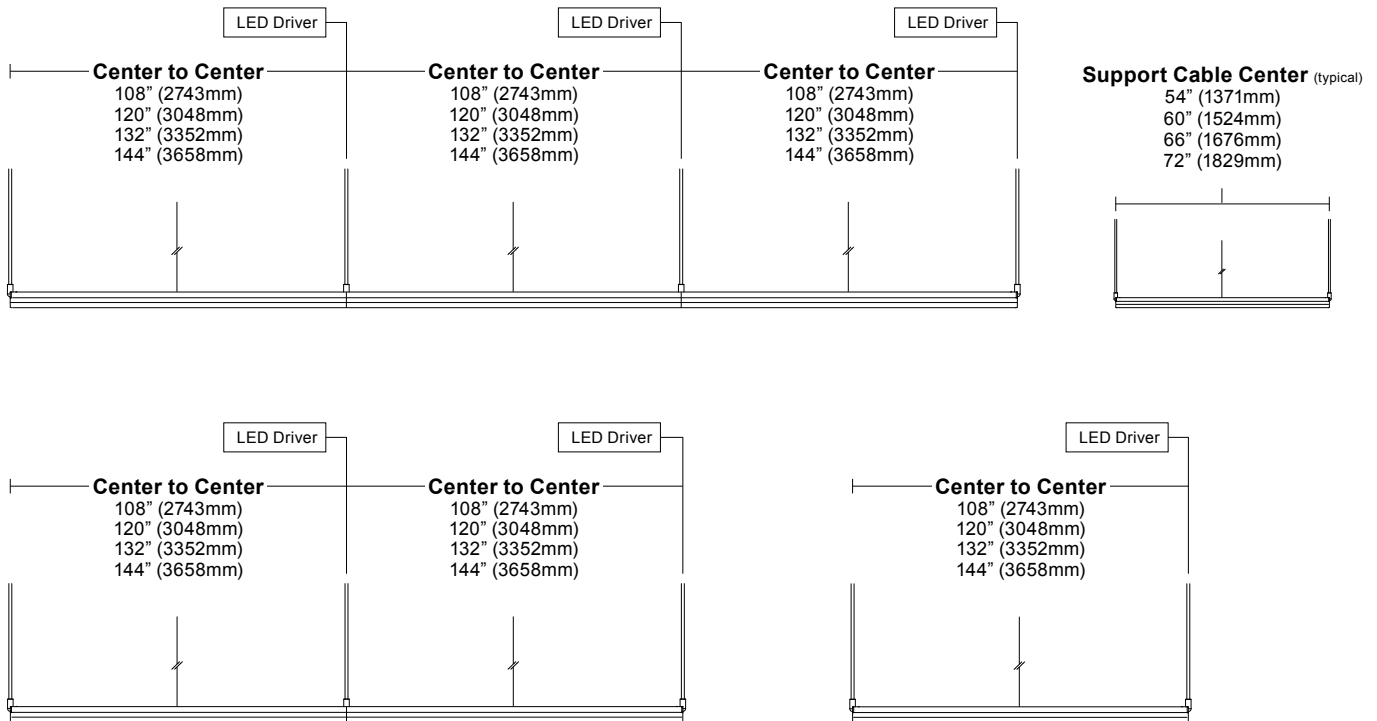

Corner and Shapes Available (Square, Rectangle, L-Shape, U-Shape, ZigZag) [See Guide](#) for details.

vodeCONNECT Sensors

Canopy with integrated sensor

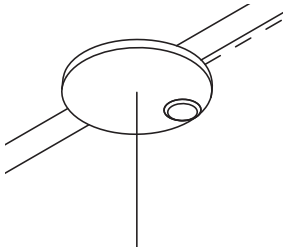

Sensor partners



Integrated canopy sensor layout ¹

1 sensor per fixture. See [vodeCONNECT brochure](#) for more details.

NOTES: 1. Available with Large Round Canopy only.

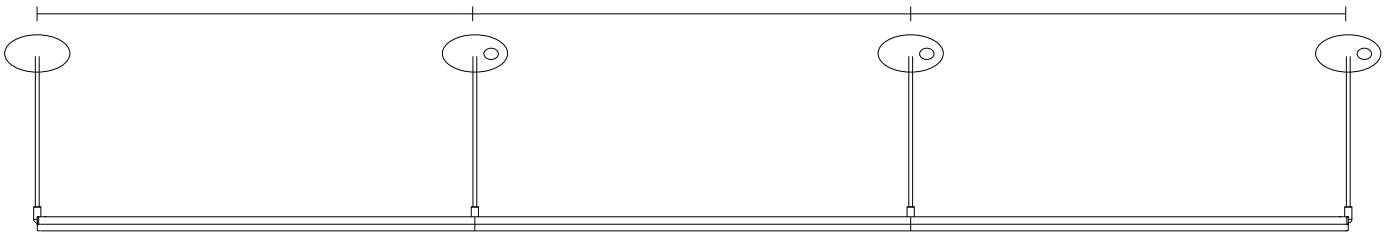

Compatible sensors



Lutron Athena



Legrand Wattstopper



Enlighted Micro Sensor

Power and Controls

Power Type	Class 2 (<60V output) constant current driver.
Dimming Controls	Dimming (0.1%, 1%), 0-10V, DALI, DMX, Hi-lume 1% are available. See Power Guide for details.
Input Voltage	120V - 277V, 50/60hz.
Power Location	Remote power. Maximum remote distance up to 100' (30.5m) depending on driver selection. See Power Guide for details.

Remote power is locating the power supply away from the fixture. Remote power comes in two housing styles: brick style and linear style. Consult [Power Guide](#) to determine which type you will receive.

Remote Brick Power Housing

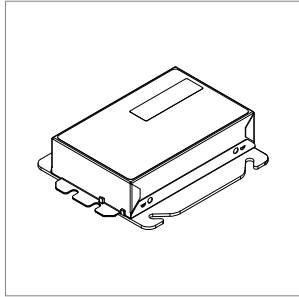

Supplied for some remote power applications. One remote power supply housing is supplied for each rail. Provided driver mounting plate fits standard 4" metal, square J-Boxes with a minimum volume of 21 in³ (J-Box not provided). See [Tech Sheet](#) for details.

Remote Linear Power Housing

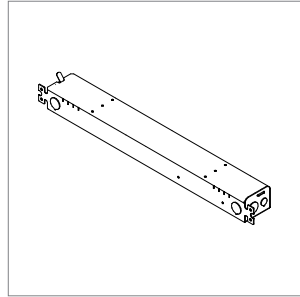

One remote power supply housing is supplied with each power supply. All Vode linear remote drivers come in a 0.054" (0.8mm) formed galvanized steel power supply housing with five (5) knockouts: (4) 1-1/8", (1) 7/8" and (1) 9/16". Accommodates standard linear power supplies. See [Tech Sheet](#) for details.

Integral Power

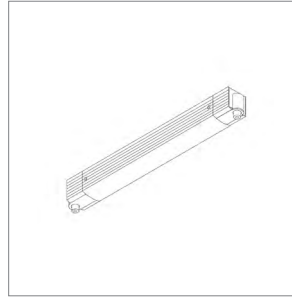

Houses integral power supply. Direct conduit feed is recommended, but integral power supply housing will mount to any standard North America 4" j-box. Mounts to most surfaces. Blocking is recommended at all arm junctions. See [Tech Sheet](#) for details.

Wire Harness

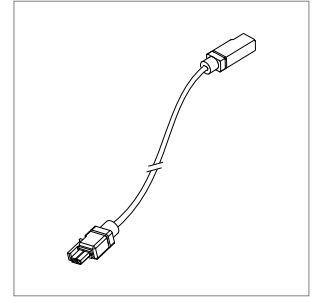

Wire harness connects driver to rail section. Lengths of 10' (3.0m) & 25' (7.6m) with snap-lock connectors for quick and easy installation. Multiple harnesses may be combined for lengths up to 100' (30.5m). See [Tech Sheet](#) for details.

Power and Controls

Flexible 1 to 1 power

For Flexible 1 to 1 Power, Vode supplies one single output driver per fixture, allowing each fixture to be controlled independently. Direct/Indirect fixtures are supplied with two single output drivers, allowing the direct and indirect lighting to be controlled independently. Consult [Power Guide](#) to determine which type you will receive.

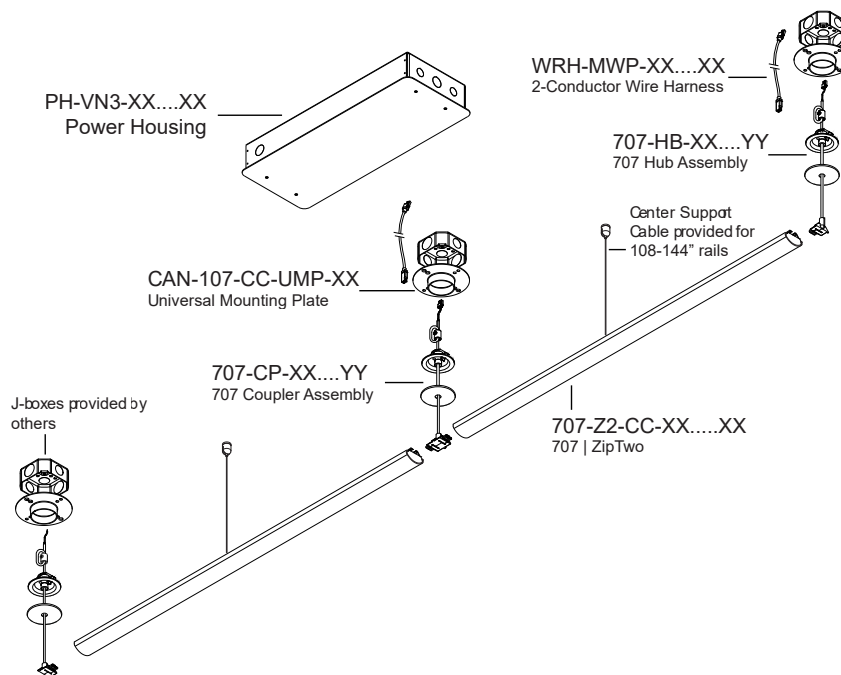

Note: Drawings not to scale, for reference only.

Optimized Power

To optimize power, Vode configures specifications with drivers that have 2 or 4 outputs. Depending on system configurations and power requirements, up to 4 fixtures can be powered from a 4-output driver. Consult [Power Guide](#) to determine which type you will receive.

IMPORTANT: Each fixture will still require individual wire harnesses, as shown below.

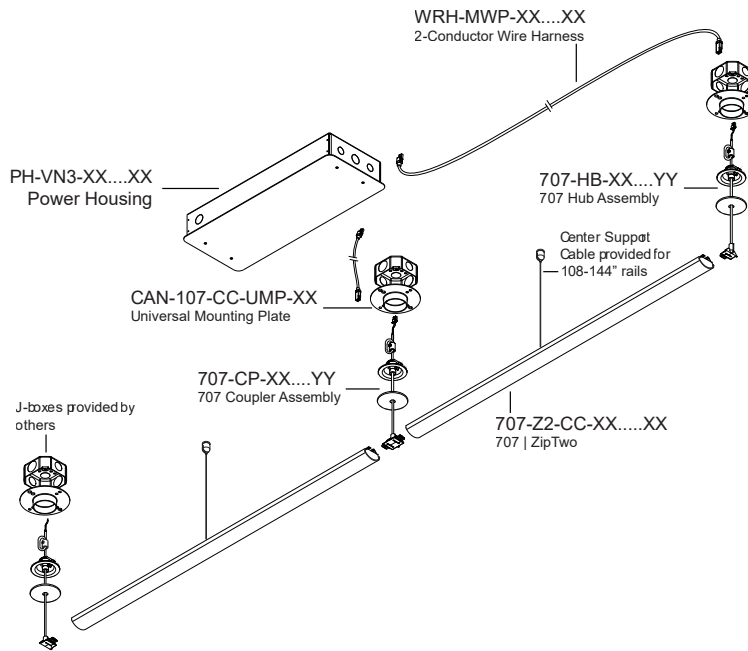

Finish

White Finish



White Rail, White Canopy/Integral Power, White Cable

Note: Drawings not to scale, for reference only.

Performance | Zipper Board Optics

Zipper Board Optics design has 72 diodes per foot (305mm).

Round 3515, Diffuse, white finish (S4-WH)

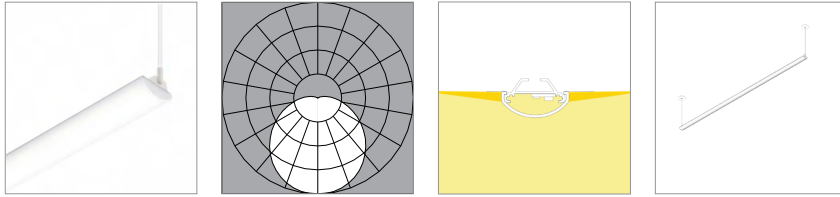

L90 >100,000 hours

90 CRI (90min., 96 avg.)

Low Output (LO)	2700K	3000K	3500K	4000K
Efficacy - Lumens per Watt	96	99	102	103
Lumens per foot (305mm)	357	368	376	380
Watts per foot (305mm)	3.8	3.8	3.8	3.8

Standard Output (SO)

Efficacy - Lumens per Watt	110	114	116	117
Lumens per foot (305mm)	714	737	752	760
Watts per foot (305mm)	6.6	6.6	6.6	6.6

High Output (HO)

Efficacy - Lumens per Watt	109	112	115	116
Lumens per foot (305mm)	1072	1105	1128	1139
Watts per foot (305mm)	9.9	9.9	9.9	9.9

Copyright © 2025 Vode Lighting LLC. All rights reserved. Vode, the Vode logo, BoxRail, FlyWing, MicroBaffle, Button Board, Zipper Board, Zero Canopy, Zero Block, VodeNODE and other names are either registered trademarks or trademarks of Vode Lighting LLC in the United States and may be registered in other countries. All other trademarks listed herein belong to their respective owners. Due to ongoing innovation, specification details may change without notice.