



Spec Guide

ZipTwo | Square 3520 | Ceiling Cable | 707



Direct lighting for open office and ambient applications.



Square 3520, Diffuse, white

Benefits & Features

Minimal Profile, Robust Design

Square profile. 1.38" (35mm) x 0.75" (19mm).

Superior Light Quality & Performance

Output up to 1474 lm/ft (HO), 150 lm/W (HO). 90 static & 90 CRI tunable white 2200K - 5000K. Custom ranges available upon request.

Adaptive Power Body

Full range dimming power for all protocols. Integral or remote power available. Remote power available up to 100' (30.5m) away.

Extensive Optics

Options of Diffuse, Critical Edge, and Side Diffuse give designers the power to create and design their space using one product.

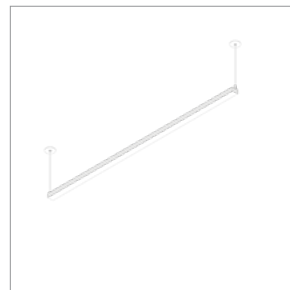

Small Round Canopy



Integral Power

Build Your Specification

707-Z2	S			CC	▶▶
---------------	----------	--	--	-----------	----

System & Rail Type	System Type	System Length	Rail Length	Mounting	Arm/Cord Length
707-Z2 ZipTwo	S Suspended	Specify overall system length in ft/in or M/mm. <i>Corner and Shapes Available See Guide for details.</i>	24 24" (610mm) 36 36" (914mm) 48 48" (1219mm) 60 60" (1524mm) 72 72" (1829mm) 96 96" (2438mm) 108 108" (2743 mm) 120 120" (3048 mm) 132 132" (3352 mm) 144 144" (3658 mm) ZZ Other rail length or layout (please specify)	CC Ceiling Cable	48 48" cord (1219mm) 96 96" cord (2438mm) ZZ Other (please specify)

See [Rail Length Chart](#) for more details.
▲ Custom lengths may result in light gaps on the fixture. See [Rail Length Chart](#) for more details.

▶▶			▶▶
----	--	--	----

Power Location	Power Type	Voltage	Emergency Power
Integral Power	Flexible 1 to 1 Power	1 120V	0 No Emergency Power
IP Integral Power	AE 0-10v, 1.0% Dimming	2 120V - 277V	ZZ Emergency Power (specify requirements)
Remote Power	AT 0-10v, 0.1% Dimming	X Not Yet Specified	
Specify mounting and harness length code example: 2R25, 2R50 ...etc.	AD DALI, 0.1% Dimming		
Mounting Option	AX DMX, 100-0% Dimming		
2R Small Round Canopy	AH Hi-lume 1% EcoSystem, Soft On / Fade to Black Technology, LDE ¹		
4R Large Round Canopy	AH2 ELV 1% 2-wire (Forward and Reverse Phase)		
Wire Harness	Optimized Power		
10 10' (3.048m) Wire Harness	Add 'O' to power type example: AEO, ATO...etc. ¹		
25 25' (7.62m) Wire Harness	VodeNODE		
50 50' (15.24m) Wire Harness	Add 'N' to power type for Flexible 1 to 1 Power		
75 75' (22.86m) Wire Harness	Add 'ON' to power type for Optimized Power example: AEN, ATN, AEON, ADON...etc. ²		
100 100' (30.48m) Wire Harness	ZZ Other (please specify)		
	See Power Guide for driver features & limitations.		

▶▶	Z				▶▶
----	----------	--	--	--	----

LED Type	Lumen Output	Color Temperature	Optics	Sensors ⁴
Z Zipper Board	LO Low Output SO Standard Output HO High Output ZZ Other (please specify) See IES Files page for details. See Power Guide for driver features & limitations.	90+ CRI 27 2700K 30 3000K 35 3500K 40 4000K ZZ Tunable White Available See Guide for details.	F5 Square 3520, Critical Edge F6 Square 3520, Diffuse ³ F9 Square 3520, Side Diffuse FA Square 3520, Single Side Diffuse	0 None ENC Canopy with integrated Enlighted Micro Sensor WSC Canopy with integrated Legrand Wattstopper sensor LAC Canopy with integrated Lutron Athena sensor ZZ Other (please specify) ²

NOTES & LIMITATIONS

- ¹ Optimized Power is not available with Hi-lume 1% EcoSystem (AHO) Power Type.
 - ² VodeNODE enclosure is not available with ELV 1% 2-wire (AH2) Power Type.
 - ³ Square 3520, Diffuse is only available in White Finish (WH).
 - ⁴ Sensors, drivers and control units that are integrated into Vode fixtures are discrete components that communicate with network lighting controls. For more information about each network lighting control system, visit the manufacturer's website for additional system information and technical data sheets.
- For general information about network lighting controls, consult the DesignLights Consortium® (DLC) [Networked Lighting Control Qualified Product List](#)

▶▶	
----	--

Finish	Options
WH White	0 None
BL Black	9 9' 18/3 Cord and Plug
	CP Chicago Plenum
	LLLC Luminaire Level Lighting Controls

Standard 5 Year Limited Warranty. See details [here](#). Contact factory for options on Limited Warranties up to 20 years.

Listed to UL standards for damp location by a Nationally Recognized Testing Laboratory (NRTL) recognized by OSHA. Certain limitations exist for each Certification. Contact factory for verification.



Applications

General Interior and Open Office



Square 3520, Diffuse



Square 3520, Critical Edge

Declare Label

All Vode Lighting linear light fixtures proudly carry the Red List Approved designation.

See [International Living Future Institute](https://www.living-future.org/) website for details.



Vode Adaptive Architectural Lighting Systems

Vode Lighting LLC

Final Assembly: Sonoma, California, US
Life Expectancy: 10+ Year(s)
End of Life Options: Recyclable (100%)

Ingredients:

Anodized Aluminum (6063-T5 Alloy); Steel; Small Electrical Component (RoHS)¹; Copper; **Fluorinated Ethylene Propylene (masterbatch)**²; Polymethyl methacrylate (PMMA); Stainless Steel; Polyoxymethylene Copolymer (POM); Styrene-butadiene polymer, hydrogenated; Poly(methyl methacrylate/butyl acrylate/styrene) (PMMA/BA/S); Styrene/butadiene copolymer; Distillates; Polypropylene; Calcium carbonate; Polycarbonate; EVA Copolymer; Methyl methacrylate (MMA); Polyphenylene Oxide; Brass; Tin, Organic

¹LBC Temp Exception RL-002 - Small Electrical Components
²LBC Temp Exception RL-023 - Wire Sheathing Subject to NFPA 90A, NFPA 262, UL® 910

Living Building Challenge Criteria: Compliant

I-13 Red List:

<input type="checkbox"/> LBC Red List Free	% Disclosed: 100% at 100ppm
<input checked="" type="checkbox"/> LBC Red List Approved	VOC Content: Not Applicable
<input type="checkbox"/> Declared	

I-10 Interior Performance: Not Applicable
I-14 Responsible Sourcing: Not Applicable

VDE-0001
 EXP. 01 JAN 2025
 Original Issue Date: 2018

MANUFACTURER RESPONSIBLE FOR LABEL ACCURACY
 INTERNATIONAL LIVING FUTURE INSTITUTE™ [living-future.org/declare](https://www.living-future.org/declare)



Structure

Rail Lengths	24" (610mm) - 144" (3658mm). Modified lengths available. See Rail Length Chart for more details.
Rail Dimensions	1.38" (35mm) x 0.75" (19mm) x length.
Construction	Extruded and machined 6063 aluminum.
Mounting	Ceiling mount to jbox or driver housing.
Cable Length	48" (1220mm) and 96" (2438mm) available. Field adjustable. Non-standard cable lengths available.
System Run Length	24" (610mm) minimum. Unlimited maximum.
Operating Temperature	32°F to 104°F (0°C to 40°C).
Humidity	0-85%, non-condensing.
System Weight	"Diffuse, Side Diffuse, Single Side Diffuse: 0.37 lbs per foot (0.17 kg per 305mm) power supply and housing not included. Critical Edge: 0.42 lbs per foot (0.19 kg per 305mm) Power supply and housing not included.

Materials

LED Board Construction	Aluminum core PCB, black LCP connectors, RoHS compliant.
Lens	High-impact extruded acrylic glass (PMMA).
Suspension Cable	Ø4mm, 22/4 AWG, TPE jacket, FEP-insulated, Red List Approved.
Power Cable	Ø3mm, 33/2 AWG, Plenum (CMP) rated semi-rigid PVC or FEP, flame tested UL-910, Red List Approved.
Cable Connectors	Unfilled black nylon, rated UL 94 V-0, halogen free, PVC or FEP overmold, RoHS compliant, Red List Approved.
Remote Linear Power Housing	20.7" x 2.375" x 2.53", 0.054" formed Galvanized Steel.
Remote Brick Power Housing	4.32" x 3.37" x .078" Galvanized Steel mounting plate.
Integral Power Housing	extruded and machined 6063 aluminum.
Center Cable Suspension	3/64" aircraft cable.

Mounting Options

Remote Power

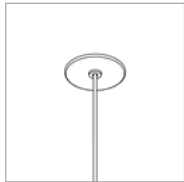

Small Round Canopy
Ø2.5" (51mm)

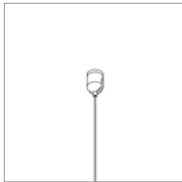

Center Support Cable
108" - 144" Rails Only
Center Support Cable for mounting to T-Bar tile available.

Integral Power (24"-72")

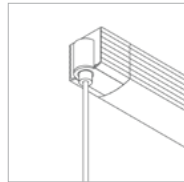

Integral Power (end)
h 1.8" (46mm)
w 1.7" (43mm)

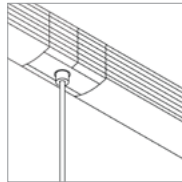

Integral Power (joint)

Dimensions

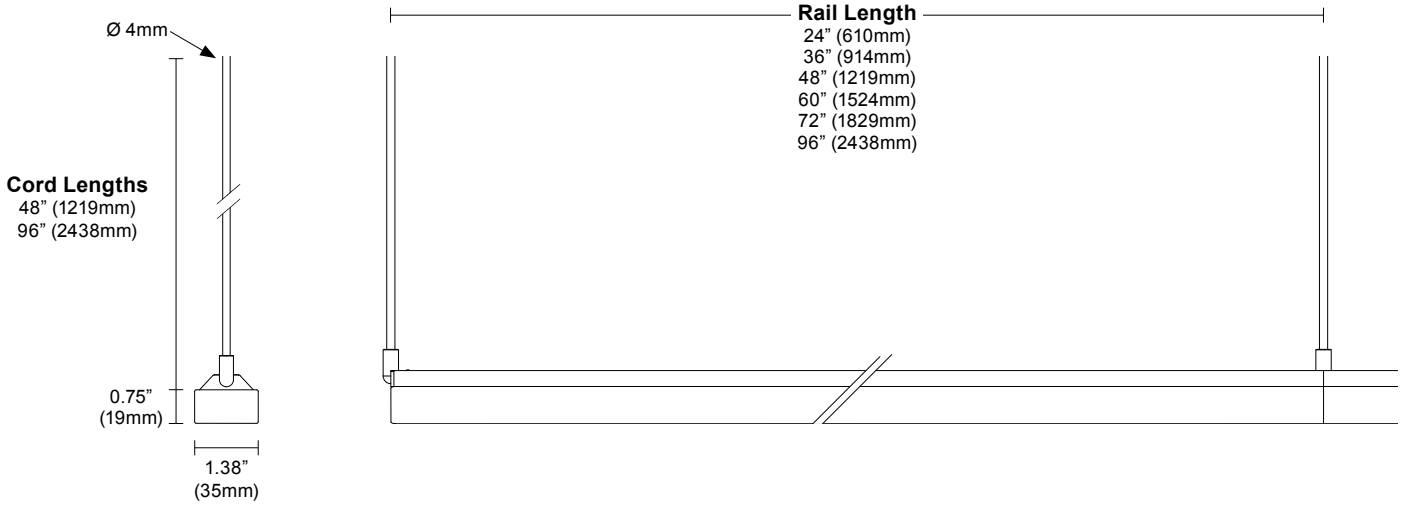

Layout

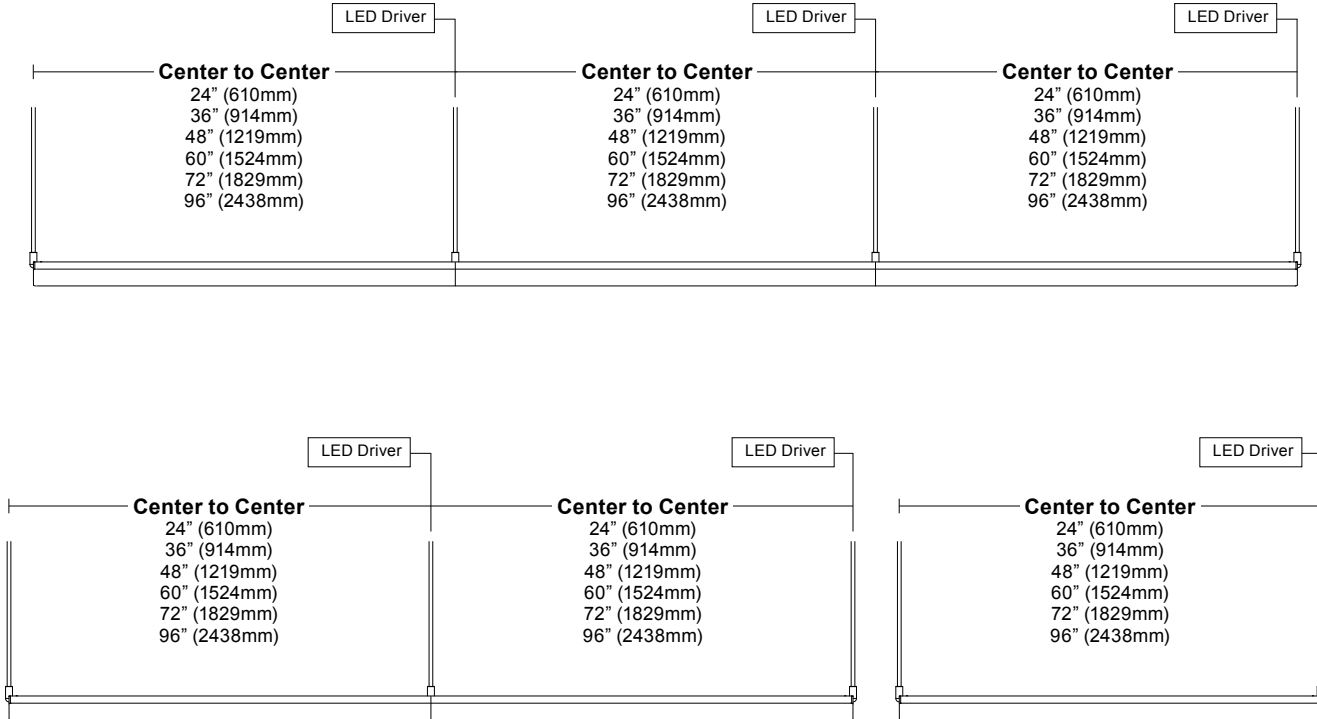

Corner and Shapes Available (Square, Rectangle, L-Shape, U-Shape, ZigZag) [See Guide](#) for details.

Dimensions

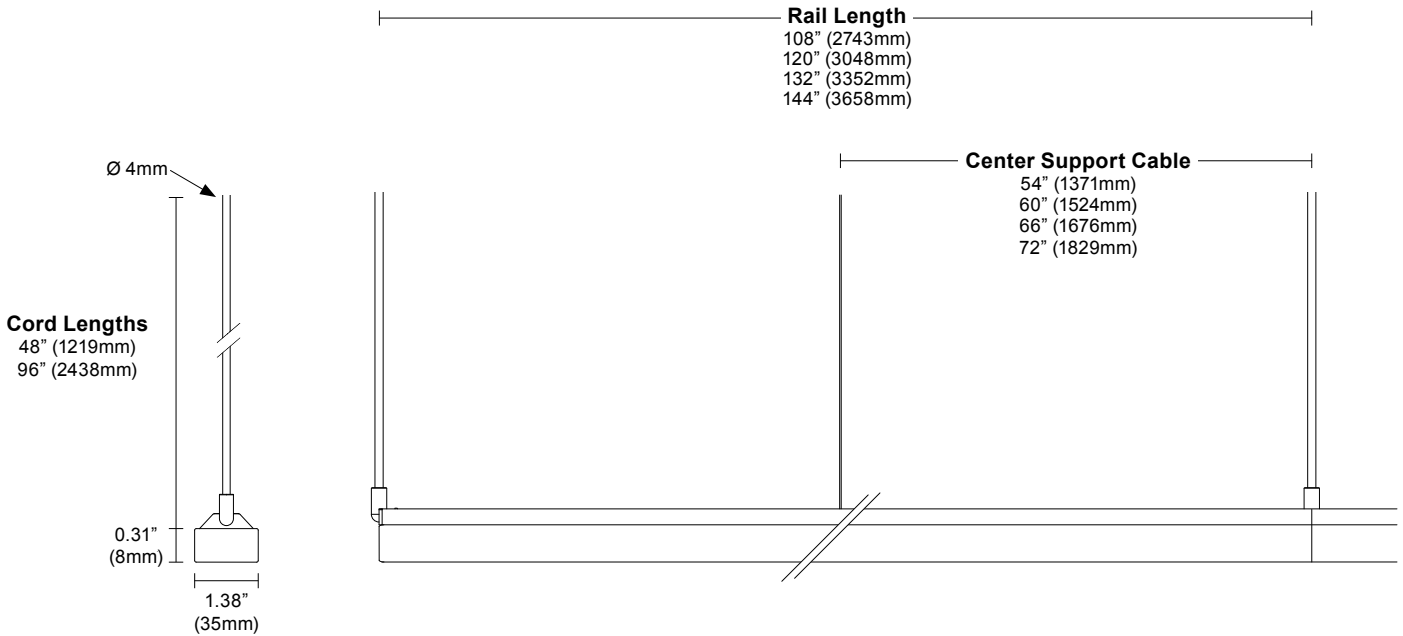

Layout

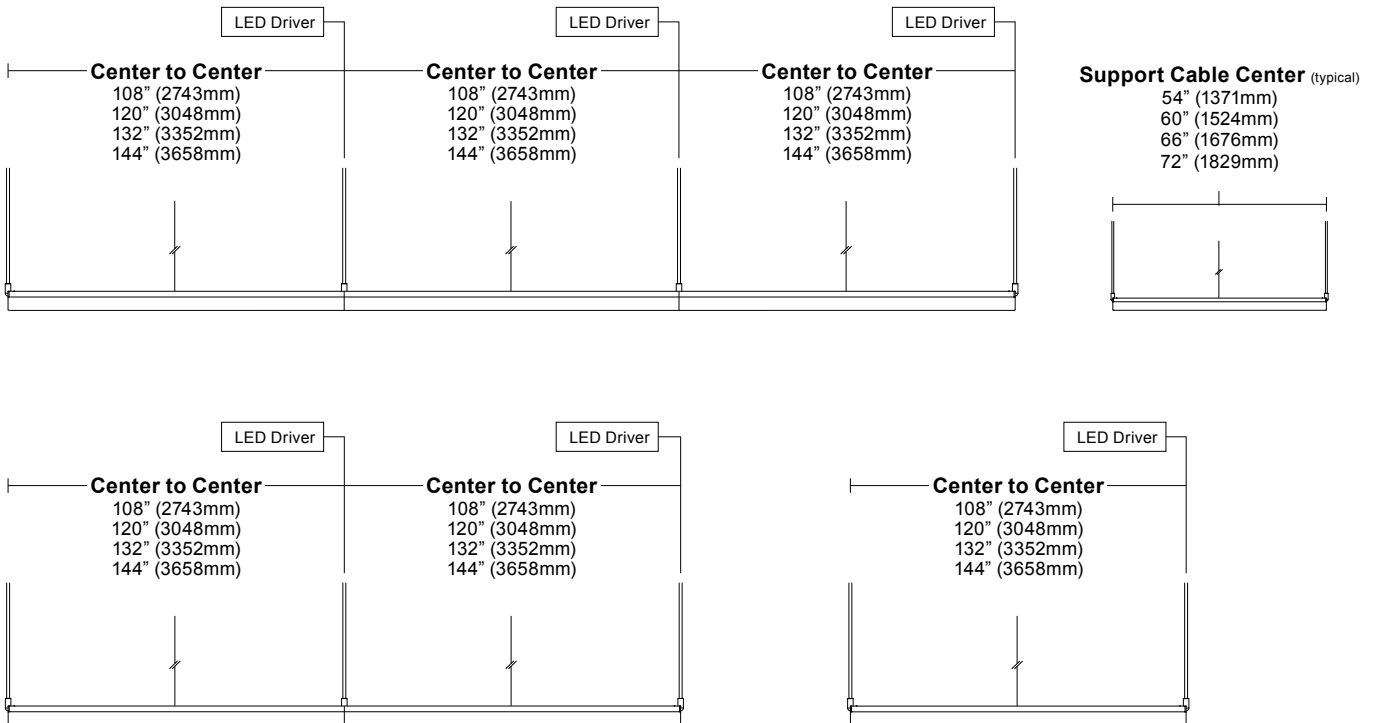

Corner and Shapes Available (Square, Rectangle, L-Shape, U-Shape, ZigZag) [See Guide](#) for details.

vodeCONNECT Sensors

Canopy with integrated sensor

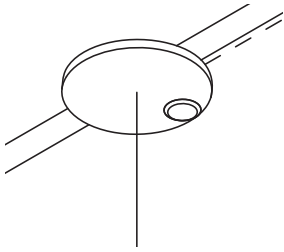

Sensor partners



Integrated canopy sensor layout ¹

1 sensor per fixture. See [vodeCONNECT brochure](#) for more details.

NOTES: 1. Available with Large Round Canopy only.

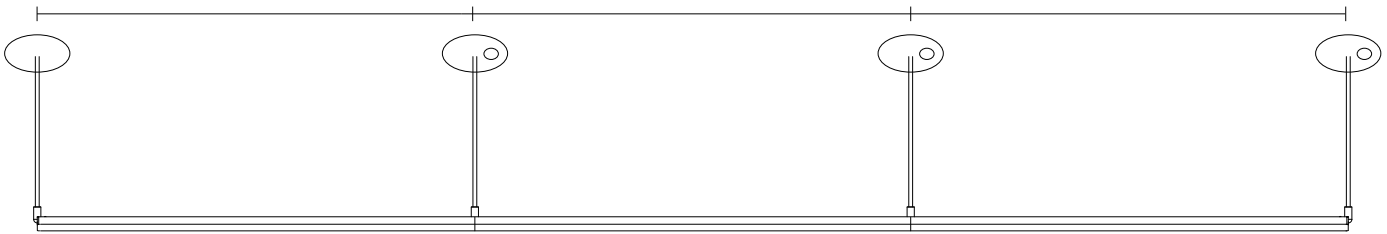

Compatible sensors



Lutron Athena



Legrand Wattstopper



Enlighted Micro Sensor

Power and Controls

Power Type	Class 2 (<60V output) constant current driver.
Dimming Controls	Dimming (0.1%, 1%), 0-10V, DALI, DMX, Hi-lume 1% are available. See Power Guide for details.
Input Voltage	120V - 277V, 50/60hz.
Power Location	Remote power. Maximum remote distance up to 100' (30.5m) depending on driver selection. See Power Guide for details.

Remote power is locating the power supply away from the fixture. Remote power comes in two housing styles: brick style and linear style. Consult [Power Guide](#) to determine which type you will receive.

Remote Brick Power Housing

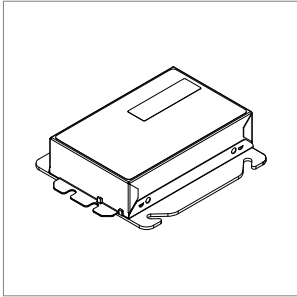

Supplied for some remote power applications. One remote power supply housing is supplied for each rail. Provided driver mounting plate fits standard 4" metal, square J-Boxes with a minimum volume of 21 in³ (J-Box not provided). See [Tech Sheet](#) for details.

Remote Linear Power Housing

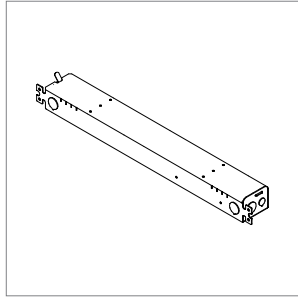

One remote power supply housing is supplied with each power supply. All Vode linear remote drivers come in a 0.054" (0.8mm) formed galvanized steel power supply housing with five (5) knockouts: (4) 1-1/8", (1) 7/8" and (1) 9/16". Accommodates standard linear power supplies. See [Tech Sheet](#) for details.

Integral Power

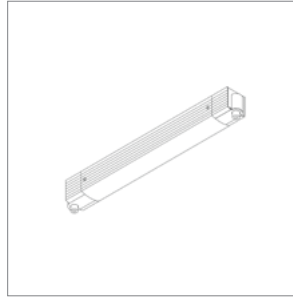

Houses integral power supply. Direct conduit feed is recommended, but integral power supply housing will mount to any standard North America 4" j-box. Mounts to most surfaces. Blocking is recommended at all arm junctions. See [Tech Sheet](#) for details.

Wire Harness

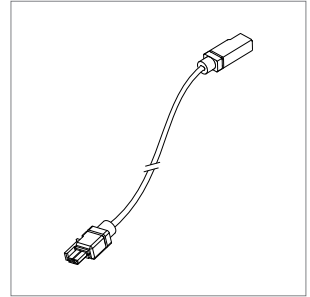

Wire harness connects driver to rail section. Lengths of 10' (3.0m) & 25' (7.6m) with snap-lock connectors for quick and easy installation. Multiple harnesses may be combined for lengths up to 100' (30.5m). See [Tech Sheet](#) for details.

Power and Controls

Flexible 1 to 1 power

For Flexible 1 to 1 Power, Vode supplies one single output driver per fixture, allowing each fixture to be controlled independently. Direct/Indirect fixtures are supplied with two single output drivers, allowing the direct and indirect lighting to be controlled independently. Consult [Power Guide](#) to determine which type you will receive.

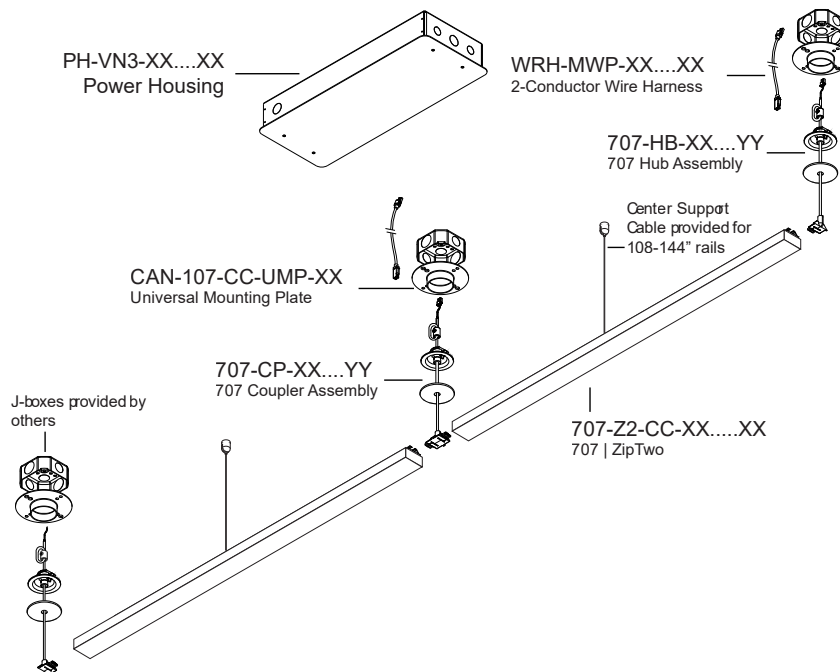

Note: Drawings not to scale, for reference only.

Optimized Power

To optimize power, Vode configures specifications with drivers that have 2 or 4 outputs. Depending on system configurations and power requirements, up to 4 fixtures can be powered from a 4-output driver. Consult [Power Guide](#) to determine which type you will receive.

IMPORTANT: Each fixture will still require individual wire harnesses, as shown below.

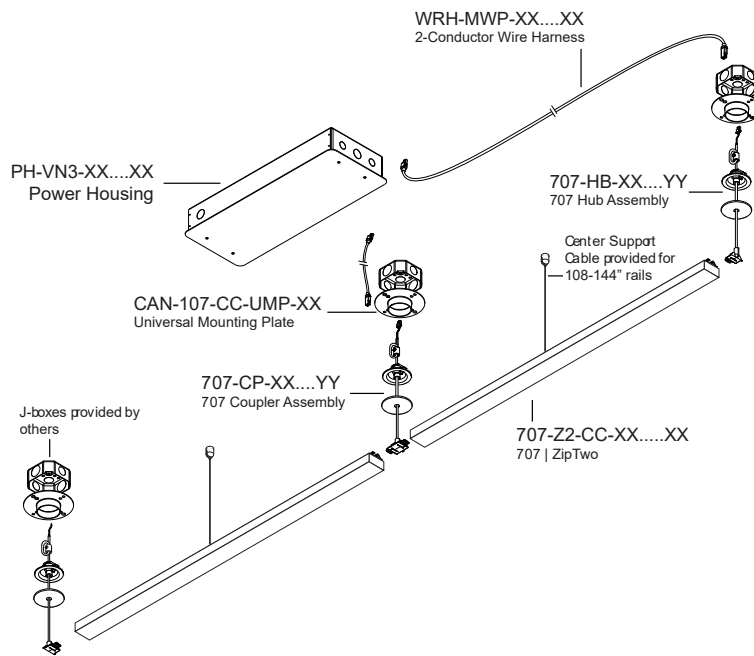

Finish

White Finish



White Rail, White Canopy/Integral Power, White Cable

Black Finish



Black Rail, Black Canopy/Integral Power, Black Cable

Note: Drawings not to scale, for reference only.

Performance | Zipper Board Optics

Zipper Board Optics design has 72 diodes per foot (305mm).

Square 3520, Critical Edge, white finish (F5-WH)

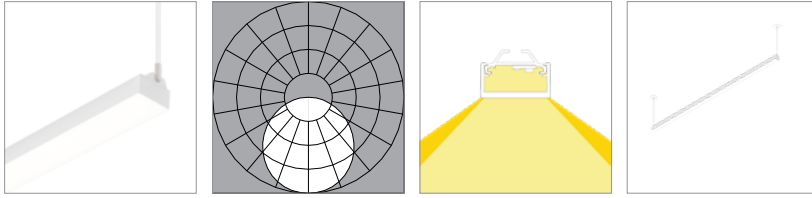

L90 >100,000 hours

	80 CRI (80min., 84 avg.)				90 CRI (90min., 96 avg.)			
	2700K	3000K	3500K	4000K	2700K	3000K	3500K	4000K
Low Output (LO)								
Efficacy - Lumens per Watt	81	83	85	85	64	66	67	68
Lumens per foot (305mm)	298	307	313	313	257	265	270	273
Watts per foot (305mm)	3.8	3.8	3.8	3.8	4.1	4.1	4.1	4.1
Standard Output (SO)								
Efficacy - Lumens per Watt	92	95	97	97	79	81	83	84
Lumens per foot (305mm)	596	614	627	627	513	530	541	546
Watts per foot (305mm)	6.6	6.6	6.6	6.6	6.6	6.6	6.6	6.6
High Output (HO)								
Efficacy - Lumens per Watt	91	94	96	96	78	81	82	83
Lumens per foot (305mm)	893	922	940	940	770	795	811	819
Watts per foot (305mm)	9.9	9.9	9.9	9.9	9.9	9.9	9.9	9.9

Square 3520, Diffuse, white finish (F6-WH)

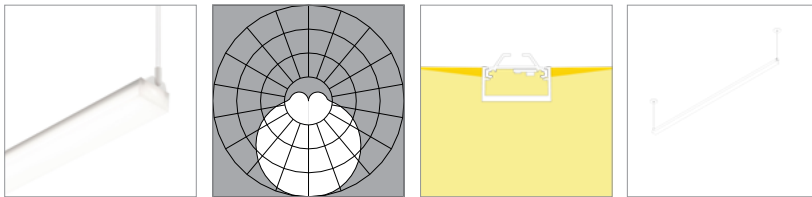

L90 >100,000 hours

	80 CRI (80min., 84 avg.)				90 CRI (90min., 96 avg.)			
	2700K	3000K	3500K	4000K	2700K	3000K	3500K	4000K
Low Output (LO)								
Efficacy - Lumens per Watt	126	130	133	133	109	112	114	115
Lumens per foot (305mm)	467	482	491	491	402	415	424	428
Watts per foot (305mm)	3.8	3.8	3.8	3.8	3.8	3.8	3.8	3.8
Standard Output (SO)								
Efficacy - Lumens per Watt	144	148	151	151	123	127	130	131
Lumens per foot (305mm)	934	963	983	983	805	830	847	856
Watts per foot (305mm)	6.6	6.6	6.6	6.6	6.6	6.6	6.6	6.6
High Output (HO)								
Efficacy - Lumens per Watt	142	147	150	150	123	126	129	130
Lumens per foot (305mm)	1401	1445	1474	1474	1207	1245	1271	1284
Watts per foot (305mm)	9.9	9.9	9.9	9.9	9.9	9.9	9.9	9.9

Performance | Zipper Board Optics

Zipper Board Optics design has 72 diodes per foot (305mm).

Square 3520, Side Diffuse, white finish (F9-WH)

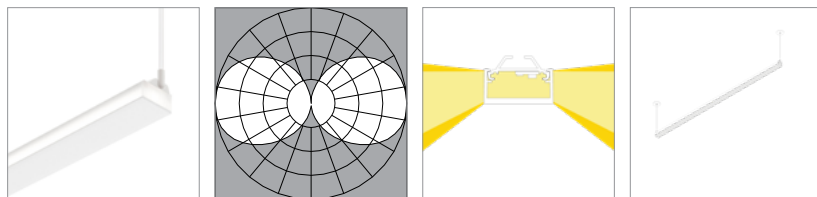

L90 >100,000 hours

	80 CRI (80min., 84 avg.)				90 CRI (90min., 96 avg.)			
	2700K	3000K	3500K	4000K	2700K	3000K	3500K	4000K
Low Output (LO)								
Efficacy - Lumens per Watt	71	73	75	75	61	63	64	65
Lumens per foot (305mm)	262	270	276	276	226	233	238	240
Watts per foot (305mm)	3.8	3.8	3.8	3.8	3.8	3.8	3.8	3.8
Standard Output (SO)								
Efficacy - Lumens per Watt	81	83	85	85	70	72	73	74
Lumens per foot (305mm)	524	541	552	552	452	466	476	481
Watts per foot (305mm)	6.6	6.6	6.6	6.6	6.6	6.6	6.6	6.6
High Output (HO)								
Efficacy - Lumens per Watt	80	83	84	84	69	71	73	73
Lumens per foot (305mm)	786	811	828	828	678	699	714	721
Watts per foot (305mm)	9.9	9.9	9.9	9.9	9.9	9.9	9.9	9.9

Square 3520, Single Side Diffuse, white finish (FA-WH)

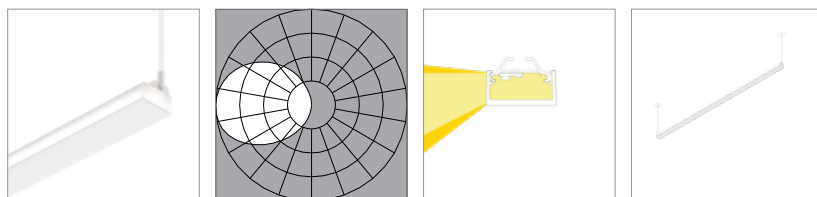

L90 >100,000 hours

	80 CRI (80min., 84 avg.)				90 CRI (90min., 96 avg.)			
	2700K	3000K	3500K	4000K	2700K	3000K	3500K	4000K
Low Output (LO)								
Efficacy - Lumens per Watt	46	47	48	48	40	41	42	42
Lumens per foot (305mm)	168	174	177	177	145	150	153	154
Watts per foot (305mm)	3.8	3.8	3.8	3.8	3.8	3.8	3.8	3.8
Standard Output (SO)								
Efficacy - Lumens per Watt	52	54	55	55	45	47	47	48
Lumens per foot (305mm)	337	348	355	355	290	300	306	309
Watts per foot (305mm)	6.6	6.6	6.6	6.6	6.6	6.6	6.6	6.6
High Output (HO)								
Efficacy - Lumens per Watt	52	53	54	54	45	46	47	47
Lumens per foot (305mm)	505	521	532	532	436	449	459	463
Watts per foot (305mm)	9.9	9.9	9.9	9.9	9.9	9.9	9.9	9.9

Performance | Zipper Board Optics

Zipper Board Optics design has 72 diodes per foot (305mm).

Square 3520, Critical Edge, black finish (F5-BL)

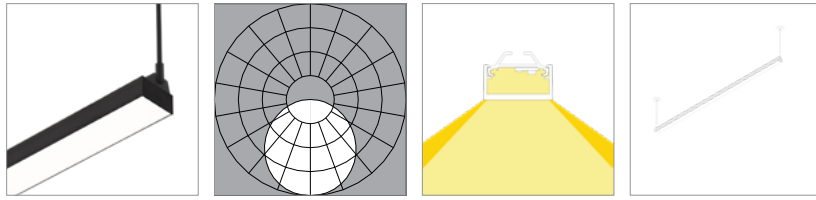

L90 >100,000 hours

	80 CRI (80min., 84 avg.)				90 CRI (90min., 96 avg.)			
	2700K	3000K	3500K	4000K	2700K	3000K	3500K	4000K
Low Output (LO)								
Efficacy - Lumens per Watt	50	51	53	53	43	44	45	46
Lumens per foot (305mm)	184	190	194	194	159	164	167	169
Watts per foot (305mm)	3.8	3.8	3.8	3.8	3.8	3.8	3.8	3.8

Standard Output (SO)								
Efficacy - Lumens per Watt	57	59	60	60	49	50	51	52
Lumens per foot (305mm)	368	380	387	387	317	327	334	337
Watts per foot (305mm)	6.6	6.6	6.6	6.6	6.6	6.6	6.6	6.6

High Output (HO)								
Efficacy - Lumens per Watt	56	58	59	59	49	50	51	52
Lumens per foot (305mm)	552	570	581	581	476	491	501	506
Watts per foot (305mm)	9.9	9.9	9.9	9.9	9.9	9.9	9.9	9.9

Square 3520, Side Diffuse, black finish (F9-BL)

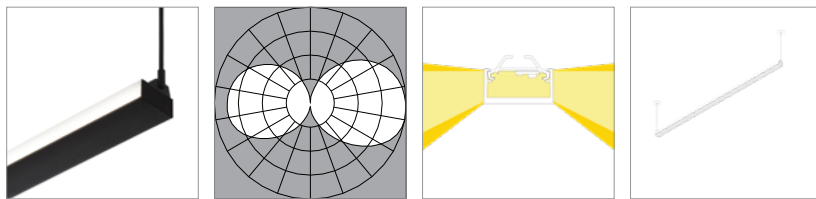

L90 >100,000 hours

	80 CRI (80min., 84 avg.)				90 CRI (90min., 96 avg.)			
	2700K	3000K	3500K	4000K	2700K	3000K	3500K	4000K
Low Output (LO)								
Efficacy - Lumens per Watt	36	37	37	37	31	32	32	33
Lumens per foot (305mm)	130	134	137	137	112	116	118	119
Watts per foot (305mm)	3.8	3.8	3.8	3.8	3.8	3.8	3.8	3.8

Standard Output (SO)								
Efficacy - Lumens per Watt	40	42	43	43	35	36	37	37
Lumens per foot (305mm)	261	269	274	274	225	232	237	239
Watts per foot (305mm)	6.6	6.6	6.6	6.6	6.6	6.6	6.6	6.6

High Output (HO)								
Efficacy - Lumens per Watt	40	41	42	42	35	36	36	37
Lumens per foot (305mm)	391	403	412	412	337	348	355	358
Watts per foot (305mm)	9.9	9.9	9.9	9.9	9.9	9.9	9.9	9.9

Performance | Zipper Board Optics

Zipper Board Optics design has 72 diodes per foot (305mm).

Square 3520, Single Side Diffuse, black finish (FA-BL)

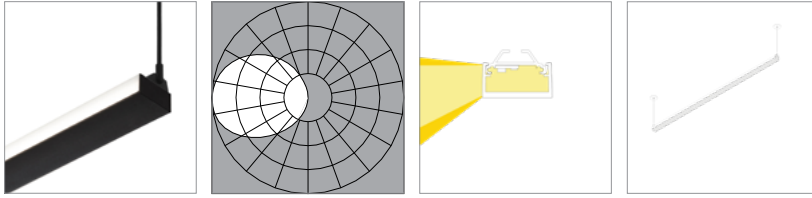

L90 >100,000 hours

	80 CRI (80min., 84 avg.)				90 CRI (90min., 96 avg.)			
	2700K	3000K	3500K	4000K	2700K	3000K	3500K	4000K
Low Output (LO)								
Efficacy - Lumens per Watt	22	22	23	23	19	19	20	20
Lumens per foot (305mm)	79	82	83	83	68	70	72	72
Watts per foot (305mm)	3.8	3.8	3.8	3.8	3.8	3.8	3.8	3.8
Standard Output (SO)								
Efficacy - Lumens per Watt	25	25	26	26	21	22	23	23
Lumens per foot (305mm)	158	163	166	166	136	141	144	145
Watts per foot (305mm)	6.6	6.6	6.6	6.6	6.6	6.6	6.6	6.6
High Output (HO)								
Efficacy - Lumens per Watt	24	25	26	26	21	22	22	22
Lumens per foot (305mm)	237	245	250	250	204	211	215	217
Watts per foot (305mm)	9.9	9.9	9.9	9.9	9.9	9.9	9.9	9.9

Copyright © 2025 Vode Lighting LLC. All rights reserved. Vode, the Vode logo, BoxRail, FlyWing, MicroBaffle, Button Board, Zipper Board, Zero Canopy, Zero Block, VodeNODE and other names are either registered trademarks or trademarks of Vode Lighting LLC in the United States and may be registered in other countries. All other trademarks listed herein belong to their respective owners. Due to ongoing innovation, specification details may change without notice.