



Spec Guide

ZipTwo | Square 5020 | 707



Direct lighting for open office and ambient applications.



Square 5020, Critical Edge, white

Benefits & Features

Minimal Profile, Robust Design

Rectangular profile. 2" (51mm) x .75" (19mm).

Superior Light Quality & Performance

Output up to 1021 lm/ft (HO), 104 lm/W (HO). 90 static, 90 CRI RGBW, & 90 CRI tunable white 2200K - 5000K. Custom ranges available upon request.

Versatile Mounting, Easy Installation

Magnet with tape-on metal strip or low profile clip allow for mounting to almost any surface or T-Bar ceiling.

Floating Plane of Light

Clean lines created by Critical Edge™ optic and a wide luminous surface without diode image.

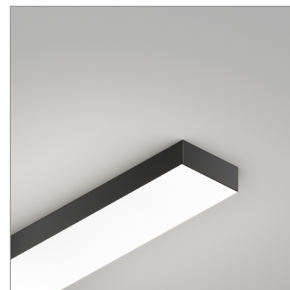

Square 5020, Critical Edge, black

Build Your Specification

707-Z2	SL				0
--------	----	--	--	--	---

System & Rail Type	System Type	System Length	Rail Length	Mounting	Arm/Cord Length
707-Z2 ZipTwo	SL Standard Linear	Specify overall system length in ft/in or M/mm. <i>Corner and Shapes Available See Guide for details.</i>	24 24" (610mm) 36 36" (914mm) 48 48" (1219mm) 60 60" (1524mm) 72 72" (1829mm) 96 96" (2438mm) 108 108" (2743mm) 120 120" (3048mm) 132 132" (3352mm) 144 144" (3658mm) ZZ Other rail length or layout (please specify)	C Clip CM Clip with Micro J-Box ¹ T Magnet with Tape-On Metal Strip ² T1 9/16" T-Bar Clip, low profile T2 15/16" T-Bar Clip, low profile T3 15/16" T-Bar Clip, medium profile T4 15/16" T-Bar Clip, concealed T5 9/16" T-Bar Clip, medium profile T6 Slotted T-Bar Clip T7 Dimensional T-Bar Clip SC Strut Channel Clip ¹ DM Armstrong DynaMax ZZ Other (please specify)	0 None

See [Rail Length Chart](#) for more details.

⚠ Custom lengths may result in light gaps on the fixture. See [Rail Length Chart](#) for more details.

				Z
--	--	--	--	---

Power Location	Power Type	Voltage	Emergency Power	LED Type
Remote Power	Flexible 1 to 1 Power	1 120V 2 120V - 277V X Not Yet Specified	0 No Emergency Power ZZ Emergency Power (specify requirements)	Z Zipper Board
RP10 10' (3.048m) Wire Harness RP25 25' (7.62m) Wire Harness RP50 50' (15.24m) Wire Harness RP75 75' (22.86m) Wire Harness RP100 100' (30.48m) Wire Harness	AE 0-10V, 1.0% Dimming AT 0-10V, 0.1% Dimming AD DALI, 0.1% Dimming AX DMX, 100-0% Dimming AH Hi-Lume 1% EcoSystem, Soft On / Fade to Black Technology, LDE ¹ AH2 ELV 1% 2-wire (Forward and Reverse Phase) Optimized Power Add 'O' to power type example: AEO, ATO...etc. ³ VodeNODE Add 'N' to power type for Flexible 1 to 1 Power Add 'ON' to power type for Optimized Power example: AEN, ATN, AEON, ADON...etc. ⁴ ZZ Other (please specify) See Power Guide for driver features & limitations.			

--	--	--	--	--

Lumen Output	Color Temperature	Optics	Sensors	Finish
LO Low Output SO Standard Output HO High Output ZZ Other (please specify) See IES Files page for details. See Power Guide for driver features & limitations.	90+ CRI 27 2700K 30 3000K 35 3500K 40 4000K RGBW 90+ CRI C279 RGB Color, 2700K C309 RGB Color, 3000K C359 RGB Color, 3500K C409 RGB Color, 4000K ZZ Tunable White Available See Guide for details	W5 Square 5020, Critical Edge	0 None ZZ Other (please specify) ⁵	WH White BL Black

NOTES & LIMITATIONS

- ¹ Mounting type available with Chicago Plenum.
- ² Custom modification available for Chicago Plenum. Contact factory.
- ³ Optimized Power is not available with Hi-Lume 1% EcoSystem (AHO) Power Type.
- ⁴ VodeNODE enclosure is not available with ELV 1% 2-wire (AH2) Power Type.
- ⁵ Sensors available. Contact Vode for more information.

--

Options

- 0** None
- 9** 9' 18/3 Cord and Plug
- CPS** Chicago Plenum Fixture Adapter & Power
- CPP** Chicago Plenum Power
- CPA** Chicago Plenum Fixture Adapter

Listed to UL standards for damp location by a Nationally Recognized Testing Laboratory (NRTL) recognized by OSHA. Certain limitations exist for each Certification. Contact factory for verification.

Standard 5 Year Limited Warranty. See details [here](#). Contact factory for options on Limited Warranties up to 20 years.



Applications

General Interior and Open Office



Square 5020, Critical Edge



Square 5020, Critical Edge

Sustainability & Certifications

DECLARE

International Living Future Institute (ILFI)



All Vode Lighting linear light fixtures proudly carry the Red List Approved designation.



Vode Adaptive Architectural Lighting Systems
Vode Lighting LLC

Final Assembly: Sonoma, California, US
Life Expectancy: 10+ Year(s)
End of Life Options: Recyclable (100%)

Ingredients:

Steel; Anodized Aluminum (6063-T5 Alloy); Small Electrical Component (RoHS); Copper; **Fluorinated Ethylene Propylene (masterbatch)**; Polymethyl methacrylate (PMMA); Stainless Steel; Polyoxymethylene Copolymer (POM); Styrene-butadiene polymer, hydrogenated; Poly(methyl methacrylate/butyl acrylate/styrene) (PMMA/BA/S); Styrene/butadiene copolymer; Distillates; Polypropylene; Calcium carbonate; Polycarbonate; EVA Copolymer; Methyl methacrylate (MMA); Polyphenylene Oxide; Brass; Tin, Organic

Living Building Challenge Criteria: Compliant

I-13 Red List:

LBC Red List Free % Disclosed: 100% at 100ppm
 LBC Red List Approved VOC Content: Not Applicable
 Declared

I-10 Interior Performance: Not Applicable
I-14 Responsible Sourcing: Not Applicable

VDE-0001
 EXP. 01 FEB 2026
 Original Issue Date: 2018

MANUFACTURER RESPONSIBLE FOR LABEL ACCURACY
 INTERNATIONAL LIVING FUTURE INSTITUTE™ living-future.org/declare

Click here to learn more: International Living Future Institute

TM65NA

CIBSE & ASHRAE on Embodied Carbon

Vode recognizes TM65NA as the highest standard for understanding the embodied carbon of our fixtures.

Developed with ASHRAE, it adapts CIBSE's TM65 for North America, ensuring accurate regional assessments. It must be used alongside TM65 and follows TM65LA's framework.

System: 707 | ZipTwo | Surface Mounted
Embodied Carbon (kg CO₂e): 28.63*

***Note:** Embodied Carbon, expressed in kilograms of CO₂e is calculated using a 48" fixture and includes the LED driver.



Click here to learn more [CIBSE](#), [ASHRAE](#).

BAA X BABA

Buy American Act / Build America & Buy America Act Compliance

Vode is dedicated to supporting domestic manufacturing and ensuring compliance with BAA and BABA requirements.

Given the complexity of our products, we recommend reaching out to vodecares@vode.com for confirmation regarding compliance for your specific project.



Click here to learn more: US Department of Commerce

Structure

Rail Lengths	24" (610mm) - 144" (3658mm). Modified lengths available. See Rail Length Chart for more details.
Rail Dimensions	2" (51mm) x .75" (19mm) x length.
Construction	Extruded and machined 6063 aluminum.
Mounting	Clip, Clip with Micro J-Box, Magnet with Tape-On Metal Strip, T-Bar Clips for most grid/panel construction, Strut Channel Clip.
System Run Length	24" (610mm) minimum. Unlimited maximum.
Operating Temperature	32°F to 104°F (0°C to 40°C).
Humidity	0-95%, non-condensing. Suitable for damp locations.
System Weight	Coming Soon

Materials

LED Board Construction	Aluminum core PCB, black LCP connectors, RoHS compliant.
Lens	High-impact extruded acrylic glass (PMMA).
Power Cable	Ø3mm, 33/2 AWG, Plenum (CMP) rated semi-rigid PVC or FEP, flame tested UL-910, red list free.
Cable Connectors	Unfilled black nylon, rated UL 94 V-0, halogen free, PVC or FEP overmold, RoHS compliant, red list free.
Remote Linear Power Housing (RLP)	20.7" x 2.375" x 2.53", 0.054" formed Galvanized Steel.
Remote Brick Power Housing (RBP)	4.32" x 3.37" x .078" Galvanized Steel mounting plate.

Power and Controls

Power Type	Class 2 (<60V output) constant current driver.
Dimming Controls	Dimming (0.1%, 1%), 0-10V, DALI, DMX, Hi-lume 1% are available. See Power Guide for details.
Input Voltage	120V - 277V, 50/60hz.
Power Location	Remote power. Maximum remote distance up to 100' (30.5m) depending on driver selection. See Power Guide for details.

Remote power is locating the power supply away from the fixture. Remote power comes in two housing styles: brick style and linear style. Consult [Power Guide](#) to determine which type you will receive.

Remote Brick Power Housing

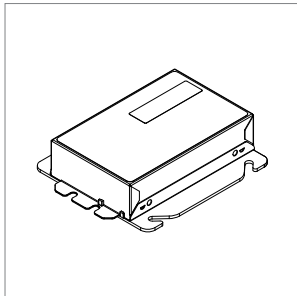

Supplied for some remote power applications. One remote power supply housing is supplied for each rail. Provided driver mounting plate fits standard 4" metal, square J-Boxes with a minimum volume of 21 in³ (J-Box not provided). See [Tech Sheet](#) for details.

Remote Linear Power Housing

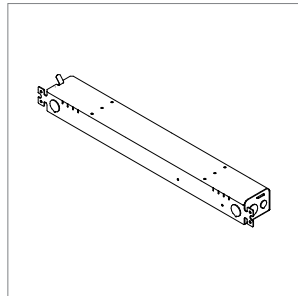

One remote power supply housing is supplied with each power supply. All Vode linear remote drivers come in a 0.054" (0.8mm) formed galvanized steel power supply housing with five (5) knockouts: (4) 1-1/8", (1) 7/8" and (1) 9/16". Accommodates standard linear power supplies. See [Tech Sheet](#) for details.

Wire Harness

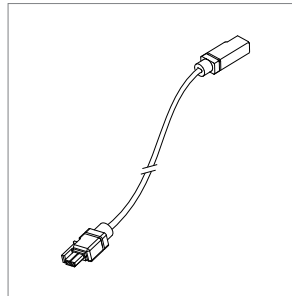

Wire harness connects driver to rail section. Lengths of 10' (3.0m) & 25' (7.6m) with snap-lock connectors for quick and easy installation. Multiple harnesses may be combined for lengths up to 100' (30.5m). See [Tech Sheet](#) for details.

Power and Controls

Flexible 1 to 1 power

For Flexible 1 to 1 Power, Vode supplies one single output driver per fixture, allowing each fixture to be controlled independently. Direct/Indirect fixtures are supplied with two single output drivers, allowing the direct and indirect lighting to be controlled independently. Consult [Power Guide](#) to determine which type you will receive.

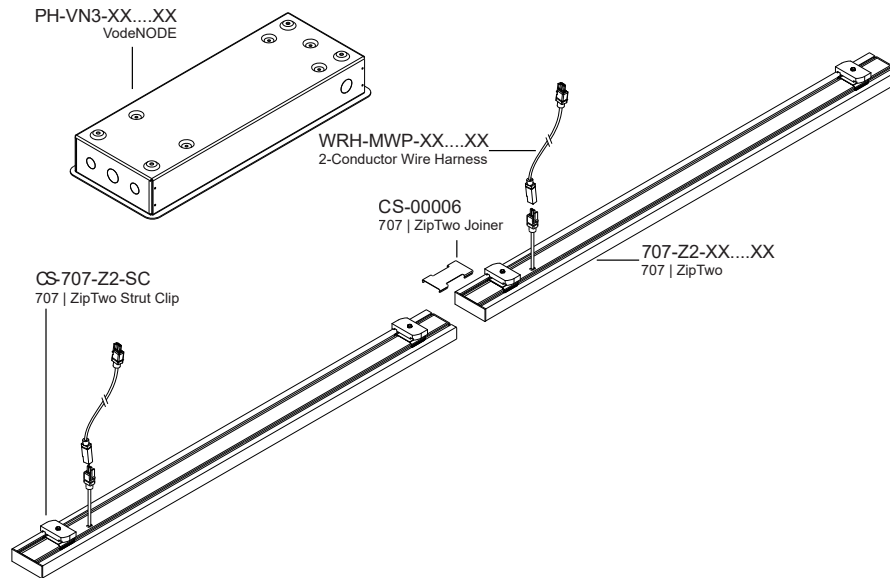

Optimized Power

To optimize power, Vode configures specifications with drivers that have 2 or 4 outputs. Depending on system configurations and power requirements, up to 4 fixtures can be powered from a 4-output driver. Consult [Power Guide](#) to determine which type you will receive.

IMPORTANT: Each fixture will still require individual wire harnesses, as shown below.

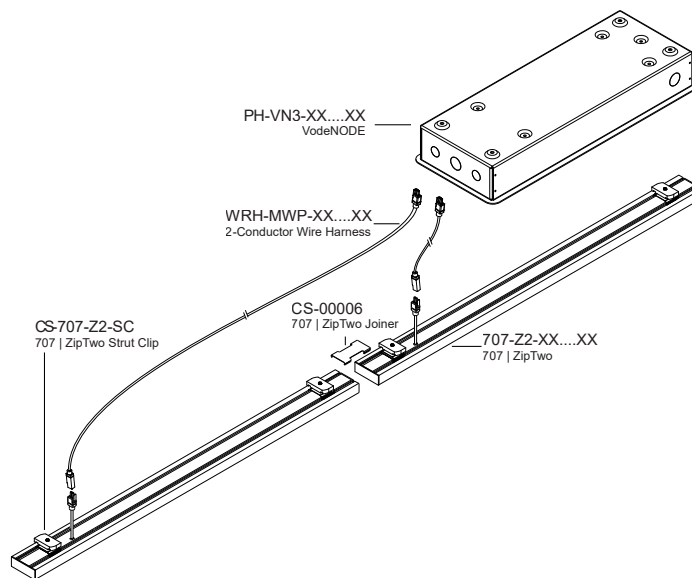

Note: Drawings not to scale, for reference only.

Dimensions

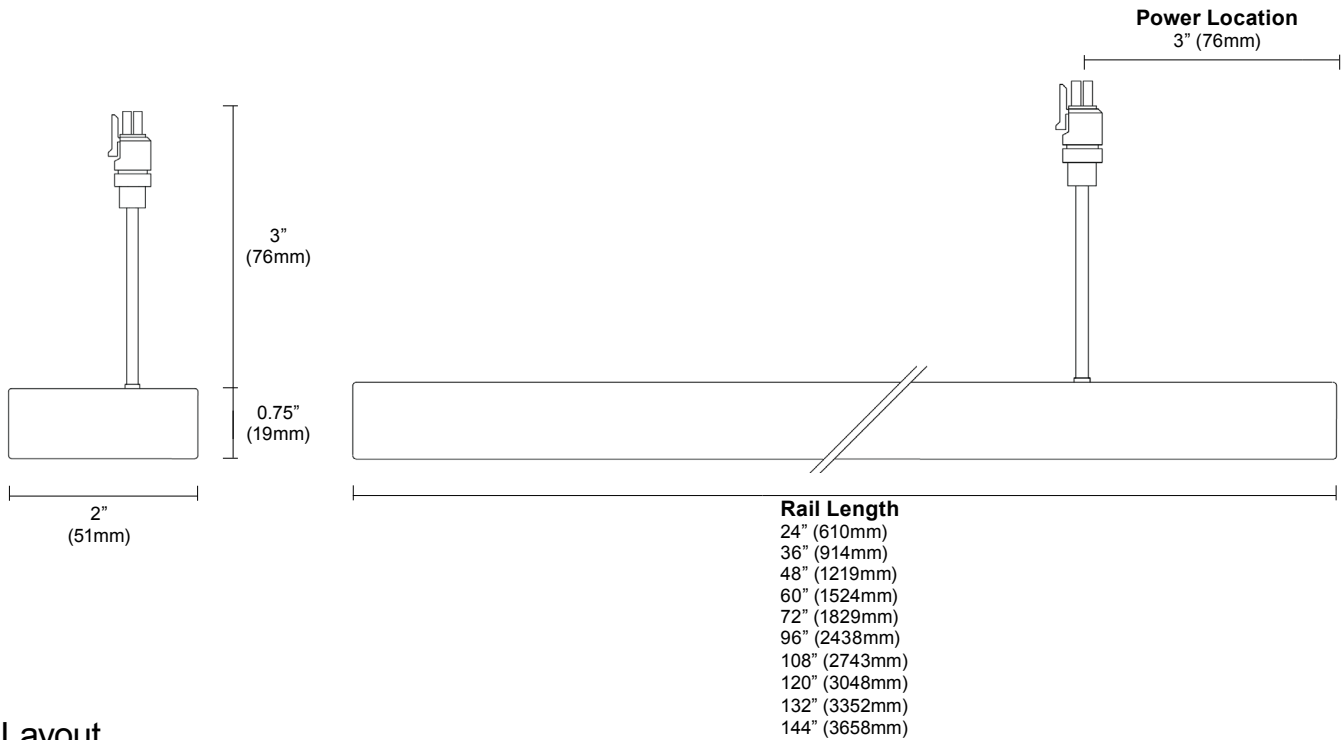

Layout

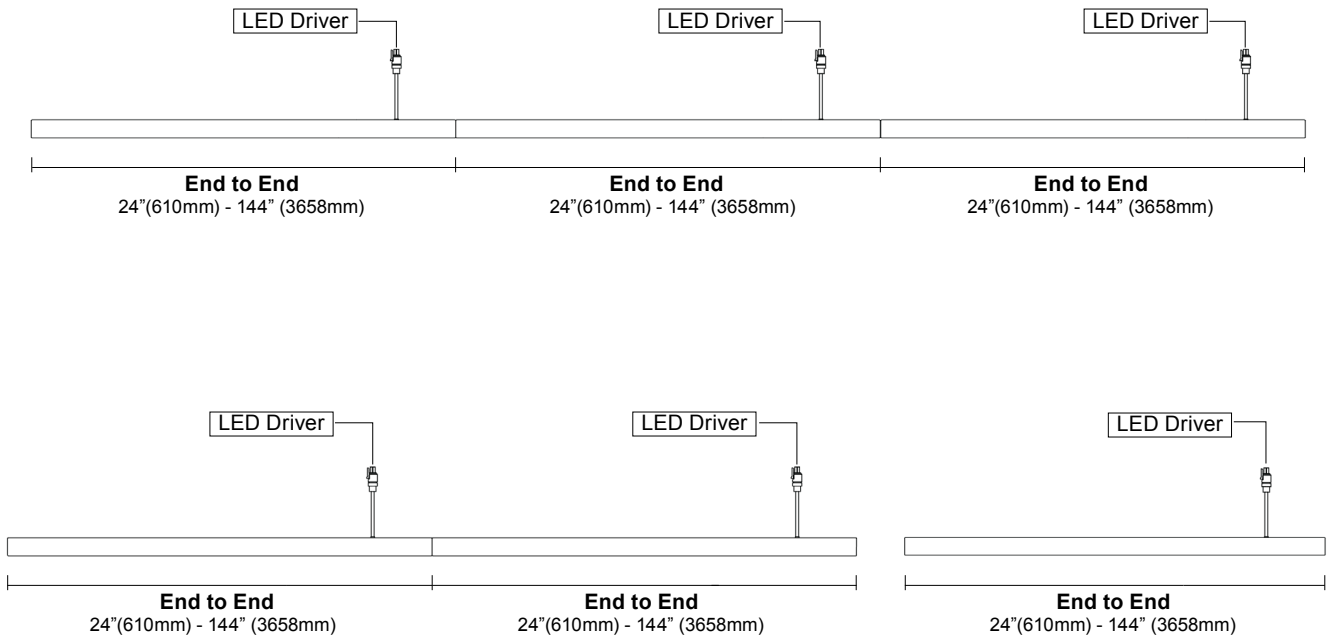

Corner and Shapes Available (Square, Rectangle, L-Shape, U-Shape, ZigZag) [See Guide](#) for details.

Mounting Options

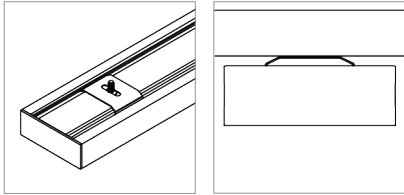

Clip (C)

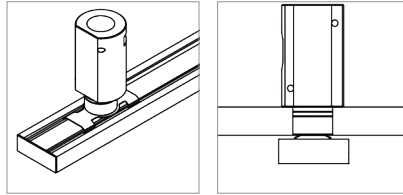

Clip with Micro J-Box (CM)

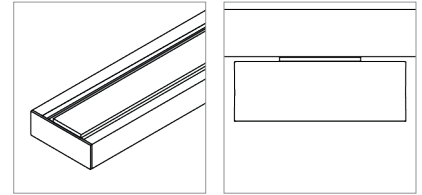

Magnet with Tape-On Metal Strip (T)

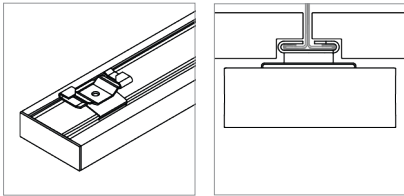

9/16" T-Bar Clip, low profile (T1)

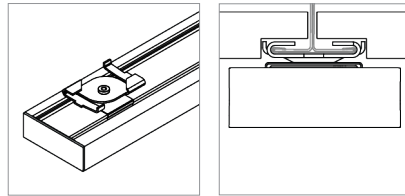

15/16" T-Bar Clip, low profile (T2)

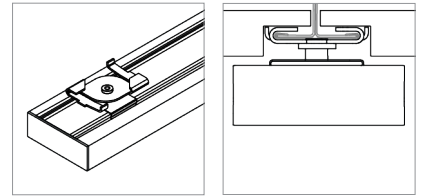

15/16" T-Bar Clip, medium profile (T3)

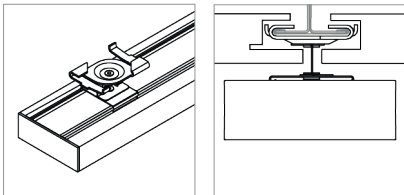

15/16" T-Bar Clip, concealed (T4)

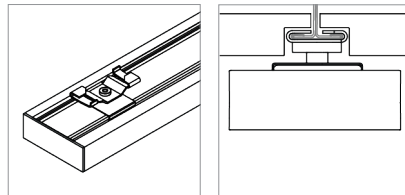

9/16" T-Bar Clip, medium profile (T5)

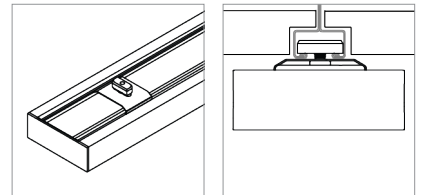

Slotted T-Bar Clip (T6)

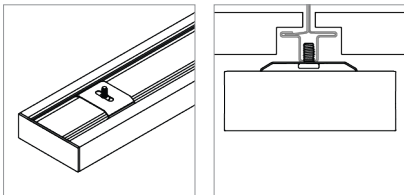

Dimensional T-Bar Clip (T7)

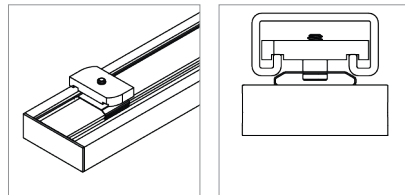

Strut Channel Clip (SC)

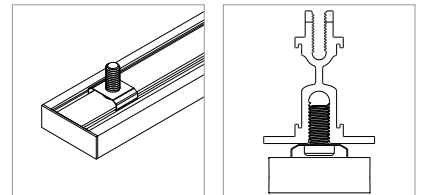

Armstrong DynaMax (DM)

See [ZipTwo Clip Guide](#) to check compatibility.

Performance | Zipper Board Optics

Zipper Board Optics design has 72 diodes per foot (305mm).

Square 5020, Critical Edge, white finish (W5-WH)

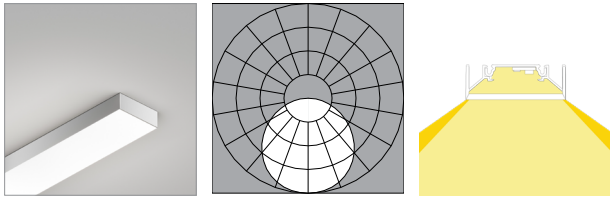

L80 >60,000 hours

	90 CRI (90min., 96 avg.)			
	2700K	3000K	3500K	4000K
Low Output (LO)				
Efficacy - Lumens per Watt	75	78	79	80
Lumens per foot (305mm)	279	288	294	296
Watts per foot (305mm)	3.8	3.8	3.8	3.8
Standard Output (SO)				
Efficacy - Lumens per Watt	86	88	90	91
Lumens per foot (305mm)	558	575	587	593
Watts per foot (305mm)	6.6	6.6	6.6	6.6
High Output (HO)				
Efficacy - Lumens per Watt	85	88	90	90
Lumens per foot (305mm)	836	863	881	889
Watts per foot (305mm)	9.9	9.9	9.9	9.9

Square 5020, Critical Edge, black finish (W5-BL)

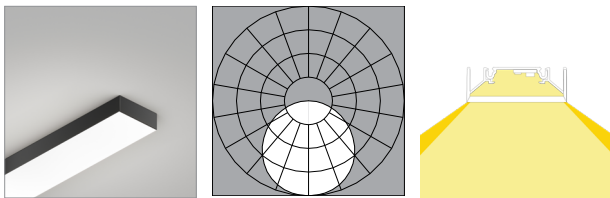

L80 >60,000 hours

	90 CRI (90min., 96 avg.)			
	2700K	3000K	3500K	4000K
Low Output (LO)				
Efficacy - Lumens per Watt	60	62	63	64
Lumens per foot (305mm)	222	229	233	236
Watts per foot (305mm)	3.8	3.8	3.8	3.8
Standard Output (SO)				
Efficacy - Lumens per Watt	68	70	72	73
Lumens per foot (305mm)	443	457	467	471
Watts per foot (305mm)	6.6	6.6	6.6	6.6
High Output (HO)				
Efficacy - Lumens per Watt	68	70	71	72
Lumens per foot (305mm)	665	686	700	707
Watts per foot (305mm)	9.9	9.9	9.9	9.9

Performance | Zipper Board Optics | RGBW

Zipper Board Optics design has 72 diodes per foot (305mm).
 RGBW (red, green, blue, and white) tested with **all channels on**.

Square 5020, Critical Edge, white finish (W5-WH)

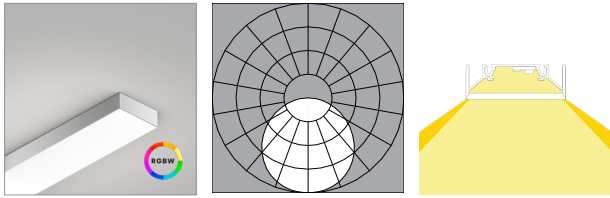

L80 >60,000 hours

RGBW Color, 90 CRI (90min., 96 avg.)

Low Output (LO)	2700K 3000K 3500K 4000K			
	Efficacy - Lumens per Watt	63	65	67
Lumens per foot (305mm)	528	545	556	562
Watts per foot (305mm)	8.5	8.5	8.5	8.5

Standard Output (SO)	2700K 3000K 3500K 4000K			
	Efficacy - Lumens per Watt	60	62	63
Lumens per foot (305mm)	793	818	834	843
Watts per foot (305mm)	13.3	13.3	13.3	13.3

Square 5020, Critical Edge, black finish (W5-BL)

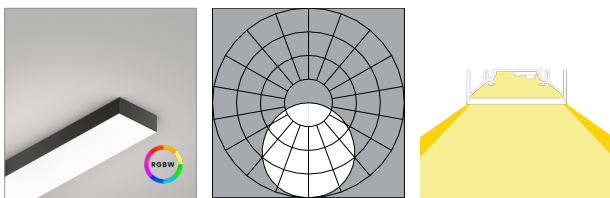

L80 >60,000 hours

RGBW Color, 90 CRI (90min., 96 avg.)

Low Output (LO)	2700K 3000K 3500K 4000K			
	Efficacy - Lumens per Watt	50	52	53
Lumens per foot (305mm)	420	433	442	447
Watts per foot (305mm)	8.5	8.5	8.5	8.5

Standard Output (SO)	2700K 3000K 3500K 4000K			
	Efficacy - Lumens per Watt	48	49	50
Lumens per foot (305mm)	630	650	663	670
Watts per foot (305mm)	13.3	13.3	13.3	13.3

Copyright © 2025 Vode Lighting LLC. All rights reserved. Vode, the Vode logo, BoxRail, FlyWing, MicroBaffle, Button Board, Zipper Board, Zero Canopy, Zero Block, VodeNODE and other names are either registered trademarks or trademarks of Vode Lighting LLC in the United States and may be registered in other countries. All other trademarks listed herein belong to their respective owners. Due to ongoing innovation, specification details may change without notice.