

Spec Guide

ZipTwo | Square 3535 | 707



Direct lighting for open office and ambient applications.



Square 3535, Critical Edge, white

Benefits & Features

Low Profile Design

Square profile. 1.38" (35mm) x 1.42" (36mm).

Superior Light Quality & Performance

Output up to 1316 lm/ft (HO), 135 lm/W (HO). 90 static, 90 CRI RGBW, & 90 CRI tunable white 2200K - 5000K. Custom ranges available upon request.

Versatile Mounting, Easy Installation

Magnet with tape-on metal strip or low profile clip allow for mounting to almost any surface or T-Bar ceiling.

Extensive Optics

Options of Diffuse, Critical Edge, and Side Diffuse give designers the power to create and design their space using one product.

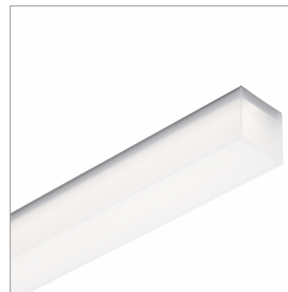

Square 3535, Diffuse, white

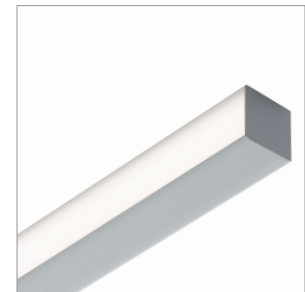

Square 3535, Side Diffuse, white

Build Your Specification

707-Z2	SL				0 >>
--------	----	--	--	--	------

System & Rail Type	System Type	System Length	Rail Length	Mounting	Arm/Cord Length
707-Z2 ZipTwo	SL Standard Linear	Specify overall system length in ft/in or M/mm. <i>Corner and Shapes Available See Guide for details.</i>	24 24" (610mm) 36 36" (914mm) 48 48" (1219mm) 60 60" (1524mm) 72 72" (1829mm) 96 96" (2438mm) 108 108" (2743mm) 120 120" (3048mm) 132 132" (3352mm) 144 144" (3658mm) ZZ Other rail length or layout (please specify) See Rail Length Chart for more details.	C Clip CM Clip with Micro J-Box ¹ T Magnet with Tape-On Metal Strip ² T1 9/16" T-Bar Clip, low profile T2 15/16" T-Bar Clip, low profile T3 15/16" T-Bar Clip, medium profile T4 15/16" T-Bar Clip, concealed T5 9/16" T-Bar Clip, medium profile T6 Slotted T-Bar Clip T7 Dimensional T-Bar Clip SC Strut Channel Clip ¹ DM Armstrong DynaMax ZZ Other (please specify)	0 None

⚠ Custom lengths may result in light gaps on the fixture. See [Rail Length Chart](#) for more details.

>>				Z >>
----	--	--	--	------

Power Location	Power Type	Voltage	Emergency Power	LED Type
Remote Power	Flexible 1 to 1 Power	1 120v 2 120v-277v X Not Yet Specified	0 No Emergency Power ZZ Emergency Power (specify requirements)	Z Zipper Board
RP10 10' (3.048m) Wire Harness RP25 25' (7.62m) Wire Harness RP50 50' (15.24m) Wire Harness RP75 75' (22.86m) Wire Harness RP100 100' (30.48m) Wire Harness	AE 0-10v, 1.0% Dimming AT 0-10v, 0.1% Dimming AD DALI, 0.1% Dimming AX DMX, 100-0% Dimming AH Hi-lume 1% EcoSystem, Soft On / Fade to Black Technology, LDE ¹ AH2 ELV 1% 2-wire (Forward and Reverse Phase) Optimized Power Add 'O' to power type example: AEO, ATO...etc. ³ VodeNODE Add 'N' to power type for Flexible 1 to 1 Power Add 'ON' to power type for Optimized Power example: AEN, ATN, AEON, ADON...etc. ⁴ ZZ Other (please specify) See Power Guide for driver features & limitations.			

>>				>>
----	--	--	--	----

Lumen Output	Color Temperature	Optics	Sensors (Inetgrated with Luminaire)
LO Low Output SO Standard Output HO High Output ZZ Other (please specify) See IES Files page for details. See Power Guide for driver features & limitations.	90+ CRI 27 2700K 30 3000K 35 3500K 40 4000K RGBW 90+ CRI C279 RGB Color, 2700K C309 RGB Color, 3000K C359 RGB Color, 3500K C409 RGB Color, 4000K ZZ Tunable White Available See Guide for details.	S5 Square 3535, Critical Edge S6 Square 3535, Diffuse S9 Square 3535, Side Diffuse SA Square 3535, Single Side Diffuse	0 None NLI nLight Air sensor NWI nLight Wired sensor LAI Lutron Athena sensor LVI Lutron Vive sensor ENI Enlighted Micro sensor WSI Wattstopper sensor ECI Encelium SensiLUM sensor ZZ Other (please specify) ⁵

NOTES & LIMITATIONS

- ¹ Mounting type available with Chicago Plenum.
- ² Custom modification available for Chicago Plenum. Contact factory.
- ³ Optimized Power is not available with Hi-lume 1% EcoSystem (AHO) Power Type.
- ⁴ VodeNODE enclosure is not available with ELV 1% 2-wire (AH2) Power Type.
- ⁵ Sensors are available please contact Vode for more information.

>>	
----	--

Finish	Options
WH White BL Black	0 None 9 9' 18/3 Cord and Plug LLLC Luminaire Level Lighting Controls CPS Chicago Plenum Fixture Adapter & Power CPA Chicago Plenum Fixture Adapter CPP Chicago Plenum Power

Listed to UL standards for damp location by a Nationally Recognized Testing Laboratory (NRTL) recognized by OSHA. Certain limitations exist for each Certification. Contact factory for verification.

Standard 5 Year Limited Warranty. See details [here](#). Contact factory for options on Limited Warranties up to 20 years.



Applications

General Interior and Open Office



Confidential Client

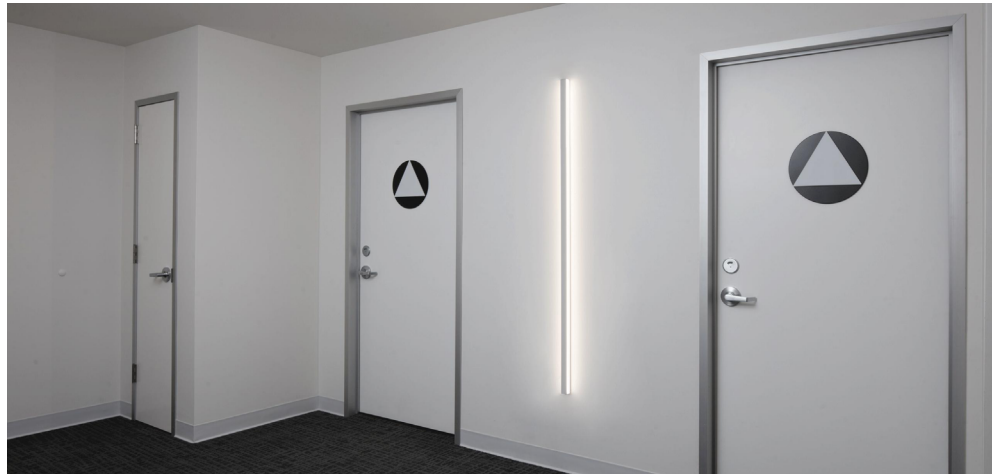

Vode Headquarters, Sonoma, CA



Open Office: rendering.

Applications

General Interior and Open Office



Open Office: rendering.



Conference Room: rendering.

Sustainability & Certifications

DECLARE

International Living Future Institute (ILFI)



All Vode Lighting linear light fixtures proudly carry the Red List Approved designation.



Vode Adaptive Architectural Lighting Systems
Vode Lighting LLC

Final Assembly: Sonoma, California, US
Life Expectancy: 10+ Year(s)
End of Life Options: Recyclable (100%)

Ingredients:

Steel; Anodized Aluminum (6063-T5 Alloy); Small Electrical Component (RoHS); Copper; **Fluorinated Ethylene Propylene (masterbatch)**; Polymethyl methacrylate (PMMA); Stainless Steel; Polyoxymethylene Copolymer (POM); Styrene-butadiene polymer, hydrogenated; Poly(methyl methacrylate/butyl acrylate/styrene) (PMMA/BA/S); Styrene/butadiene copolymer; Distillates; Polypropylene; Calcium carbonate; Polycarbonate; EVA Copolymer; Methyl methacrylate (MMA); Polyphenylene Oxide; Brass; Tin, Organic

Living Building Challenge Criteria: Compliant

I-13 Red List:

LBC Red List Free % Disclosed: 100% at 100ppm
 LBC Red List Approved VOC Content: Not Applicable
 Declared

I-10 Interior Performance: Not Applicable
I-14 Responsible Sourcing: Not Applicable

VDE-0001
 EXP. 01 FEB 2026
 Original Issue Date: 2018

MANUFACTURER RESPONSIBLE FOR LABEL ACCURACY
 INTERNATIONAL LIVING FUTURE INSTITUTE™ living-future.org/declare

Click here to learn more: International Living Future Institute

TM65NA

CIBSE & ASHRAE on Embodied Carbon

Vode recognizes TM65NA as the highest standard for understanding the embodied carbon of our fixtures.

Developed with ASHRAE, it adapts CIBSE’s TM65 for North America, ensuring accurate regional assessments. It must be used alongside TM65 and follows TM65LA’s framework.

System: 707 | ZipTwo | Surface Mounted
Embodied Carbon (kg CO₂e): 28.63*

***Note:** Embodied Carbon, expressed in kilograms of CO₂e is calculated using a 48” fixture **and includes the LED driver.**



Click here to learn more [CIBSE](#), [ASHRAE](#).

BAA X BABA

Buy American Act / Build America & Buy America Act Compliance

Vode is dedicated to supporting domestic manufacturing and ensuring compliance with BAA and BABA requirements.

Given the complexity of our products, we recommend reaching out to vodecares@vode.com for confirmation regarding compliance for your specific project.



Click here to learn more: US Department of Commerce

Structure

Rail Lengths	24" (610mm) - 144" (3658mm). Modified lengths available. See Rail Length Chart for more details.
Rail Dimensions	1.38" (35mm) x 1.42" (36mm) x length.
Construction	Extruded and machined 6063 aluminum.
Mounting	Clip, Clip with Micro J-Box, Magnet with Tape-On Metal Strip, T-Bar Clips for most grid/panel construction, Strut Channel Clip.
System Run Length	24" (610mm) minimum. Unlimited maximum.
Operating Temperature	32°F to 104°F (0°C to 40°C).
Humidity	0-95%, non-condensing. Suitable for damp locations.
System Weight	0.25lbs per ft (0.11kg per 305mm). Power supply and housing not included.

Materials

LED Board Construction	Aluminum core PCB, black LCP connectors, RoHS compliant.
Lens	High-impact extruded acrylic glass (PMMA).
Power Cable	Ø3mm, 33/2 AWG, Plenum (CMP) rated semi-rigid PVC or FEP, flame tested UL-910 (<i>PVC free in 2020</i>).
Cable Connectors	Unfilled black nylon, rated UL 94 V-0, halogen free, PVC or FEP overmold, RoHS compliant (<i>PVC free in 2020</i>).
Remote Linear Power Housing (RLP)	20.7" x 2.375" x 2.53", 0.054" formed Galvanized Steel.
Remote Brick Power Housing (RBP)	4.32" x 3.37" x .078" Galvanized Steel mounting plate.

Power and Controls

Power Type	Class 2 (<60V output) constant current driver.
Dimming Controls	Dimming (0.1%, 1%), 0-10V, DALI, DMX, Hi-lume 1% are available. See Power Guide for details.
Input Voltage	120V - 277V, 50/60hz.
Power Location	Remote power. Maximum remote distance up to 100' (30.5m) depending on driver selection. See Power Guide for details.

Remote power is locating the power supply away from the fixture. Remote power comes in two housing styles: brick style and linear style. Consult [Power Guide](#) to determine which type you will receive.

Remote Brick Power Housing

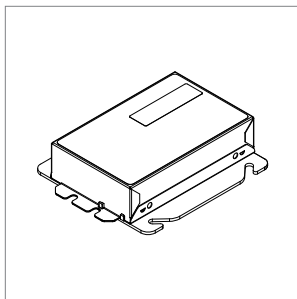

Supplied for some remote power applications. One remote power supply housing is supplied for each rail. Provided driver mounting plate fits standard 4" metal, square J-Boxes with a minimum volume of 21 in³ (J-Box not provided). See [Tech Sheet](#) for details.

Remote Linear Power Housing

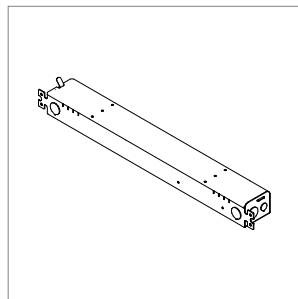

One remote power supply housing is supplied with each power supply. All Vode linear remote drivers come in a 0.054" (0.8mm) formed galvanized steel power supply housing with five (5) knockouts: (4) 1-1/8", (1) 7/8" and (1) 9/16". Accommodates standard linear power supplies. See [Tech Sheet](#) for details.

Wire Harness

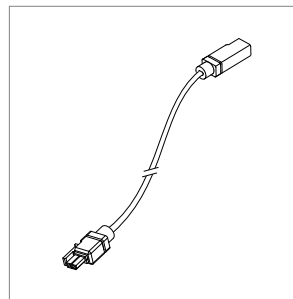

Wire harness connects driver to rail section. Lengths of 10' (3.0m) & 25' (7.6m) with snap-lock connectors for quick and easy installation. Multiple harnesses may be combined for lengths up to 100' (30.5m). See [Tech Sheet](#) for details.

Power and Controls

Flexible 1 to 1 power

For Flexible 1 to 1 Power, Vode supplies one single output driver per fixture, allowing each fixture to be controlled independently. Direct/Indirect fixtures are supplied with two single output drivers, allowing the direct and indirect lighting to be controlled independently. Consult [Power Guide](#) to determine which type you will receive.

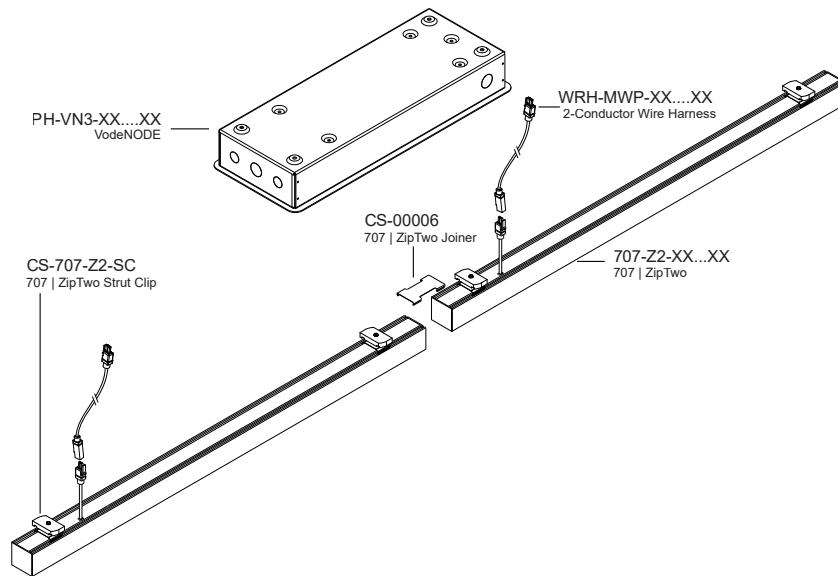

Optimized Power

To optimize power, Vode configures specifications with drivers that have 2 or 4 outputs. Depending on system configurations and power requirements, up to 4 fixtures can be powered from a 4-output driver. Consult [Power Guide](#) to determine which type you will receive.

IMPORTANT: Each fixture will still require individual wire harnesses, as shown below.

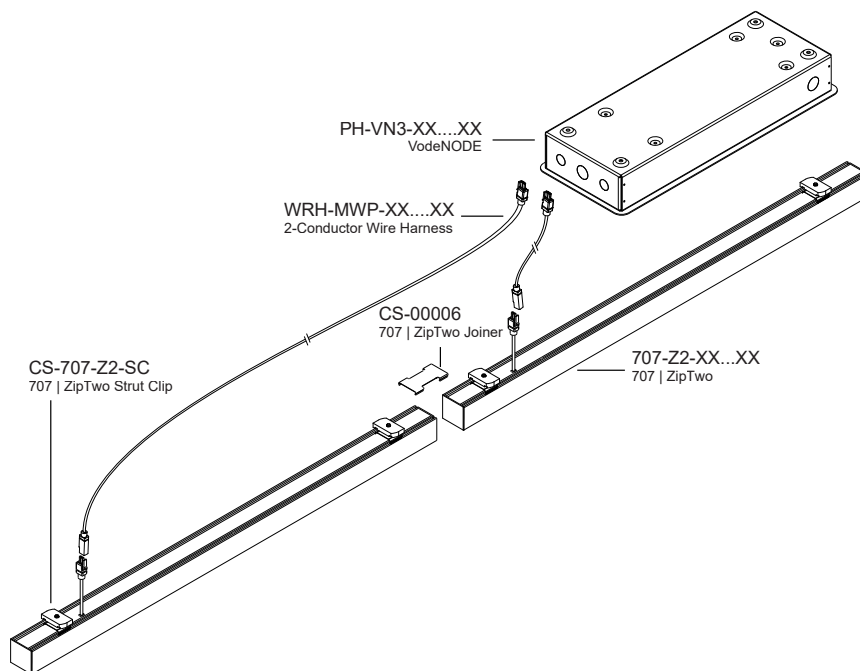

Note: Drawings not to scale, for reference only.

Dimensions

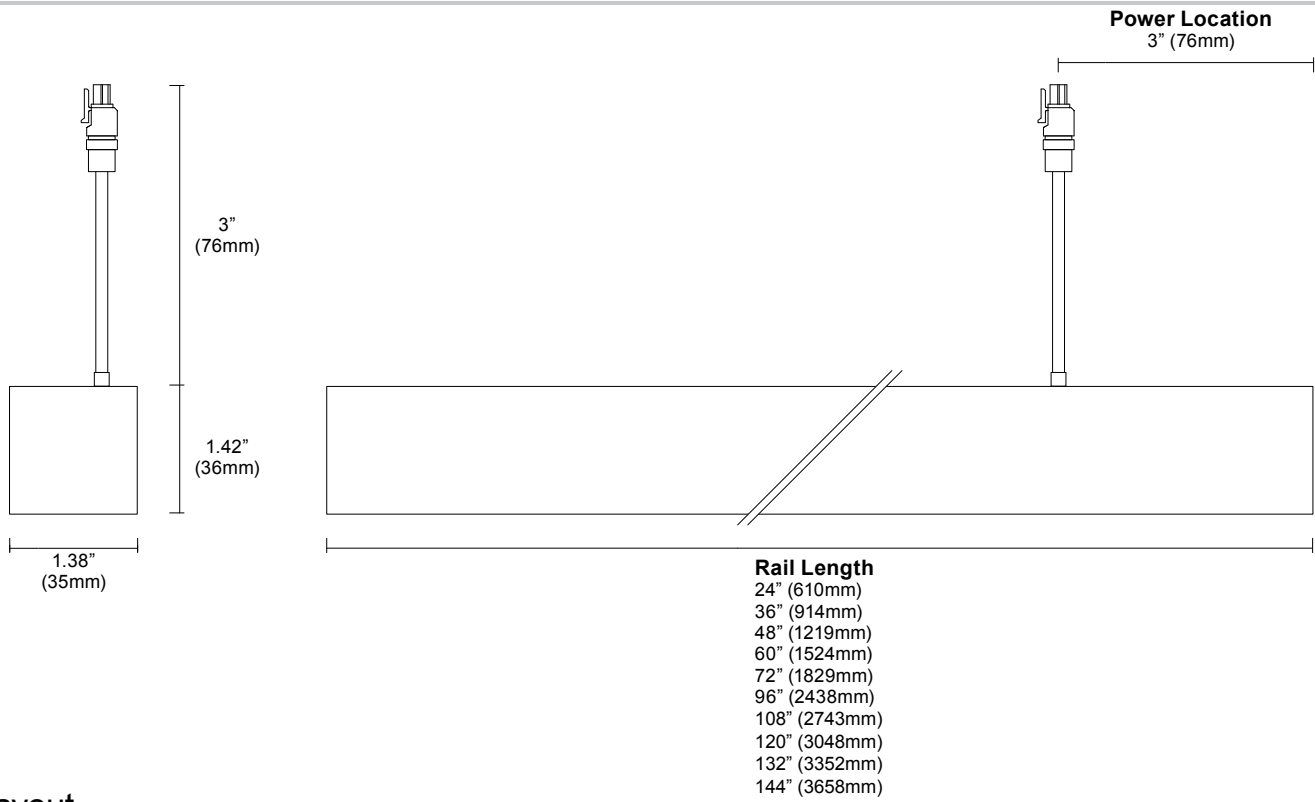

Layout

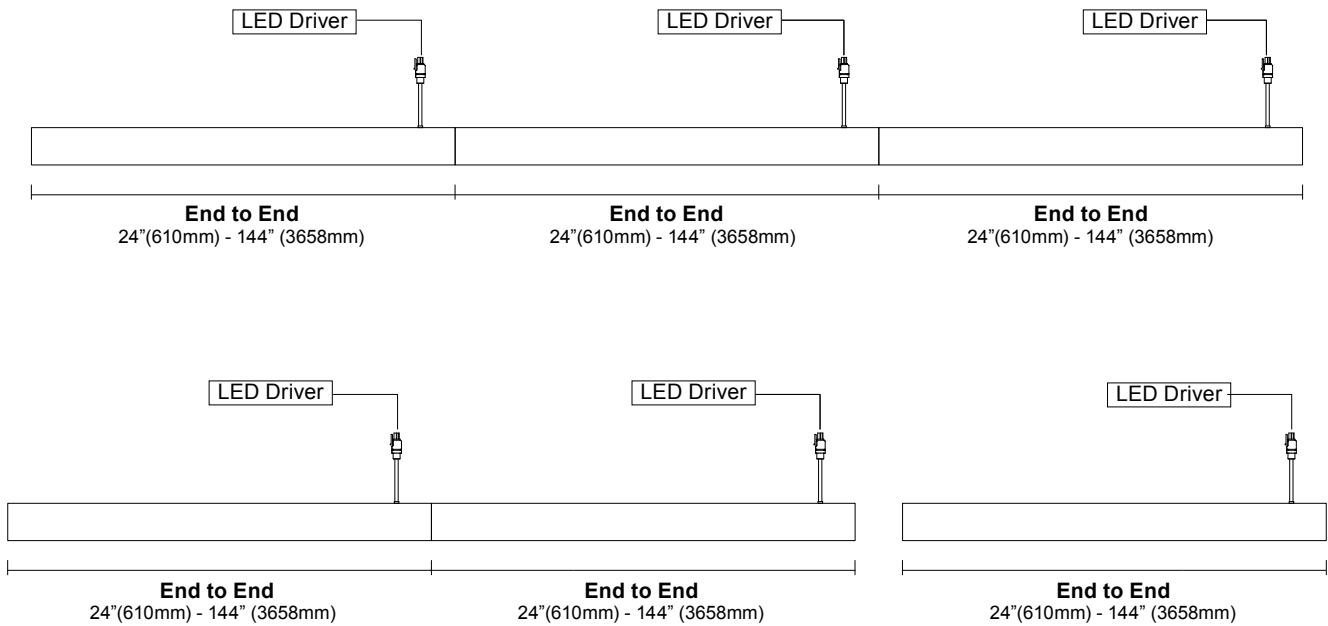

Corner and Shapes Available (Square, Rectangle, L-Shape, U-Shape, ZigZag) [See Guide](#) for details.

vodeCONNECT Sensors ¹

Luminaire with integrated sensor

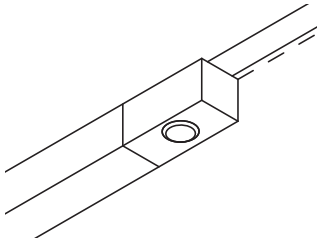

Sensor partners



Integrated sensor layout ²

¹ sensor per fixture. See [vodeCONNECT brochure](#) for more details.



	White fixture w/ Integrated Sensor	Black Fixture w/ Integrated Sensor	Sensor Compartment Length
 nLight Air			 ZipTwo 3535 w/ Integrated nLight Air 3" compartment
 nLight Wired			 ZipTwo 3535 w/ Integrated nLight Wired 6" compartment
 Lutron Athena			 ZipTwo 3535 w/ Integrated Lutron Athena 3" compartment
 Lutron Vive			 ZipTwo 3535 w/ Integrated Lutron Vive 3" compartment
 Legrand Wattstopper			 ZipTwo 3535 w/ Integrated Legrand Wattstopper 3" compartment
 Encelium SensiLUM			 ZipTwo 3535 w/ Integrated Encelium SensiLUM 3" compartment
 Enlighted Micro Sensor			 ZipTwo 3535 w/ Integrated Enlighted Micro Sensor 3" compartment

NOTES: 1. Compatible with the S5 optic only. 2. Due to large light gaps, sensors are not available for the following fixture lengths: 24", 36", 108", 132". Please contact customer service for more information.

Mounting Options

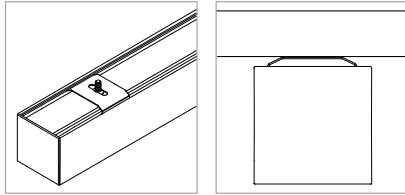

Clip (C)

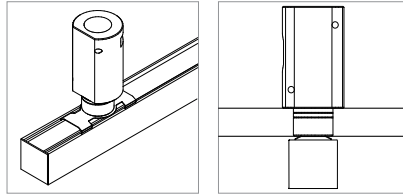

Clip with Micro J-Box (CM)

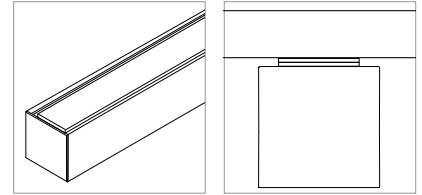

Magnet with Tape-On Metal Strip (T)

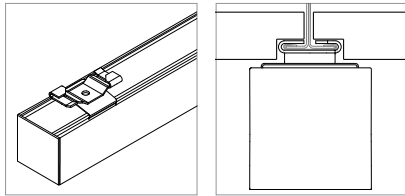

9/16" T-Bar Clip, low profile (T1)

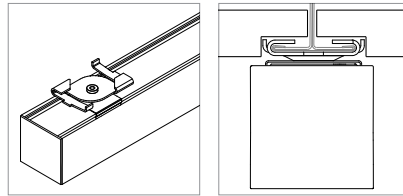

15/16" T-Bar Clip, low profile (T2)

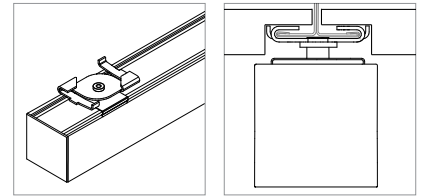

15/16" T-Bar Clip, medium profile (T3)

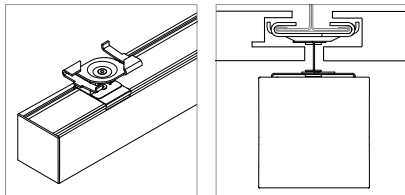

15/16" T-Bar Clip, concealed (T4)

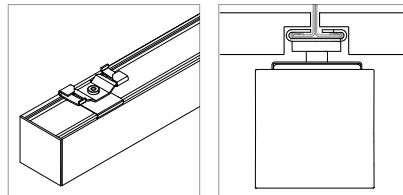

9/16" T-Bar Clip, medium profile (T5)

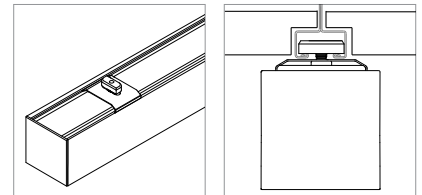

Slotted T-Bar Clip (T6)

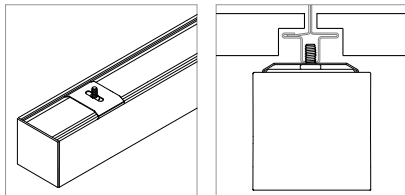

Dimensional T-Bar Clip (T7)

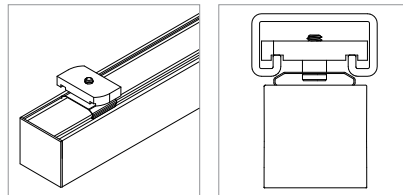

Strut Channel Clip (SC)

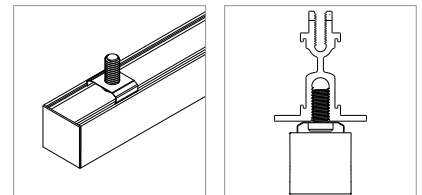

Armstrong DynaMax (DM)

See [ZipTwo Clip Guide](#) to check compatibility.

Performance | Zipper Board Optics

Zipper Board Optics design has 72 diodes per foot (305mm).

Square 3535, Critical Edge (S5)

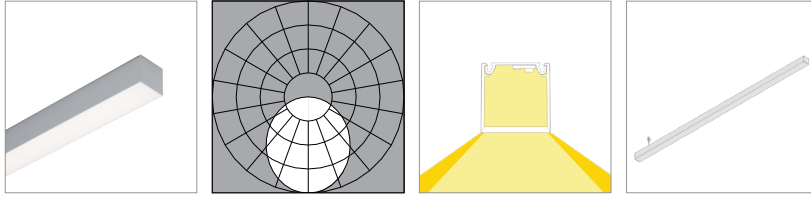

L80 >60,000 hours

90 CRI (90min., 96 avg.)

Low Output (LO)	2700K	3000K	3500K	4000K
Efficacy - Lumens per Watt	55	57	58	58
Lumens per foot (305mm)	203	209	214	216
Watts per foot (305mm)	3.8	3.8	3.8	3.8

Standard Output (SO)	2700K	3000K	3500K	4000K
Efficacy - Lumens per Watt	63	65	66	67
Lumens per foot (305mm)	406	419	427	432
Watts per foot (305mm)	6.6	6.6	6.6	6.6

High Output (HO)	2700K	3000K	3500K	4000K
Efficacy - Lumens per Watt	62	64	65	66
Lumens per foot (305mm)	609	628	641	647
Watts per foot (305mm)	9.9	9.9	9.9	9.9

Square 3535, Diffuse (S6)

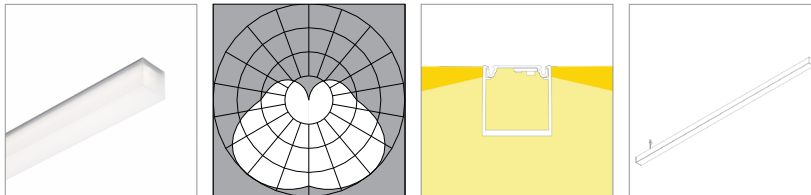

L80 >60,000 hours

90 CRI (90min., 96 avg.)

Low Output (LO)	2700K	3000K	3500K	4000K
Efficacy - Lumens per Watt	110	113	115	117
Lumens per foot (305mm)	406	419	428	432
Watts per foot (305mm)	3.8	3.8	3.8	3.8

Standard Output (SO)	2700K	3000K	3500K	4000K
Efficacy - Lumens per Watt	125	129	132	133
Lumens per foot (305mm)	813	838	856	864
Watts per foot (305mm)	6.6	6.6	6.6	6.6

High Output (HO)	2700K	3000K	3500K	4000K
Efficacy - Lumens per Watt	124	128	130	132
Lumens per foot (305mm)	1219	1258	1283	1296
Watts per foot (305mm)	9.9	9.9	9.9	9.9

Performance | Zipper Board Optics | RGBW

Zipper Board Optics design has 72 diodes per foot (305mm).
 RGBW (red, green, blue, and white) tested with **all channels on**.

Square 3535, Critical Edge (S5)

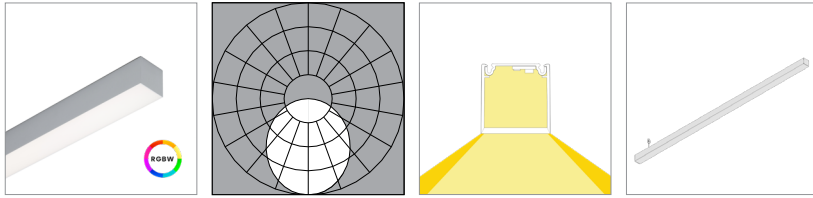

L80 >60,000 hours

RGBW Color, 90 CRI (90min., 96 avg.)

Low Output (LO)	RGBW Color, 90 CRI (90min., 96 avg.)			
	2700K	3000K	3500K	4000K
Efficacy - Lumens per Watt	46	48	49	49
Lumens per foot (305mm)	385	397	405	409
Watts per foot (305mm)	8.5	8.5	8.5	8.5

Standard Output (SO)	RGBW Color, 90 CRI (90min., 96 avg.)			
	2700K	3000K	3500K	4000K
Efficacy - Lumens per Watt	44	45	46	47
Lumens per foot (305mm)	577	595	607	614
Watts per foot (305mm)	13.3	13.3	13.3	13.3

Square 3535, Diffuse (S6)

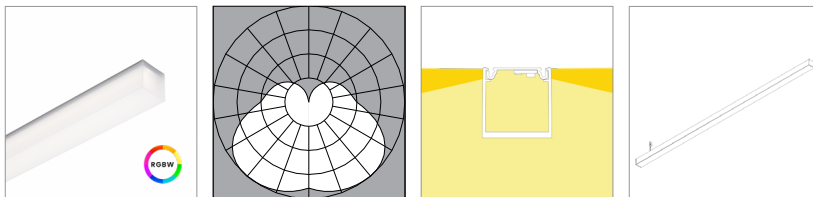

L80 >60,000 hours

RGBW Color, 90 CRI (90min., 96 avg.)

Low Output (LO)	RGBW Color, 90 CRI (90min., 96 avg.)			
	2700K	3000K	3500K	4000K
Efficacy - Lumens per Watt	42	44	45	45
Lumens per foot (305mm)	353	364	371	375
Watts per foot (305mm)	8.5	8.5	8.5	8.5

Standard Output (SO)	RGBW Color, 90 CRI (90min., 96 avg.)			
	2700K	3000K	3500K	4000K
Efficacy - Lumens per Watt	40	42	42	43
Lumens per foot (305mm)	529	546	557	562
Watts per foot (305mm)	13.3	13.3	13.3	13.3

Performance | Zipper Board Optics

Zipper Board Optics design has 72 diodes per foot (305mm).

Square 3535, Side Diffuse (S9)

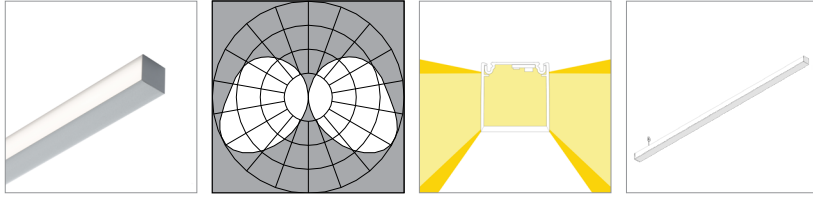

L80 >60,000 hours

90 CRI (90min., 96 avg.)

Low Output (LO)	2700K	3000K	3500K	4000K
Efficacy - Lumens per Watt	74	77	78	79
Lumens per foot (305mm)	275	284	290	292
Watts per foot (305mm)	3.8	3.8	3.8	3.8

Standard Output (SO)	2700K	3000K	3500K	4000K
Efficacy - Lumens per Watt	85	87	89	90
Lumens per foot (305mm)	550	567	579	585
Watts per foot (305mm)	6.6	6.6	6.6	6.6

High Output (HO)	2700K	3000K	3500K	4000K
Efficacy - Lumens per Watt	84	87	88	89
Lumens per foot (305mm)	825	851	869	877
Watts per foot (305mm)	9.9	9.9	9.9	9.9

Square 3535, Single Side Diffuse (SA)

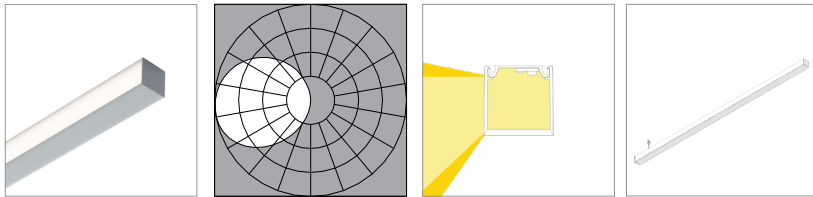

L80 >60,000 hours

90 CRI (90min., 96 avg.)

Low Output (LO)	2700K	3000K	3500K	4000K
Efficacy - Lumens per Watt	67	69	71	72
Lumens per foot (305mm)	249	257	262	264
Watts per foot (305mm)	3.8	3.8	3.8	3.8

Standard Output (SO)	2700K	3000K	3500K	4000K
Efficacy - Lumens per Watt	77	79	81	82
Lumens per foot (305mm)	497	513	524	529
Watts per foot (305mm)	6.6	6.6	6.6	6.6

High Output (HO)	2700K	3000K	3500K	4000K
Efficacy - Lumens per Watt	76	78	80	81
Lumens per foot (305mm)	746	770	785	793
Watts per foot (305mm)	9.9	9.9	9.9	9.9

Performance | Zipper Board Optics | RGBW

Zipper Board Optics design has 72 diodes per foot (305mm).
 RGBW (red, green, blue, and white) tested with **all channels on**.

Square 3535, Side Diffuse (S9)

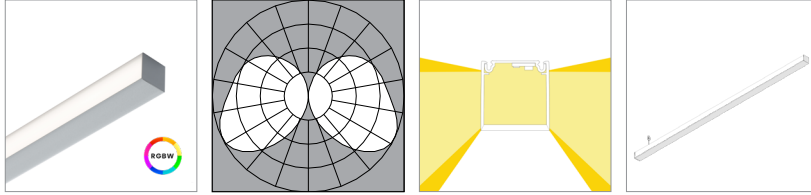

L80 >60,000 hours

	RGBW Color, 90 CRI (90min., 96 avg.)			
	2700K	3000K	3500K	4000K
Low Output (LO)				
Efficacy - Lumens per Watt	62	64	66	66
Lumens per foot (305mm)	521	538	549	554
Watts per foot (305mm)	8.5	8.5	8.5	8.5

	RGBW Color, 90 CRI (90min., 96 avg.)			
	2700K	3000K	3500K	4000K
Standard Output (SO)				
Efficacy - Lumens per Watt	60	64	66	66
Lumens per foot (305mm)	791	843	864	875
Watts per foot (305mm)	13.3	13.3	13.3	13.3

Square 3535, Single Side Diffuse (SA)

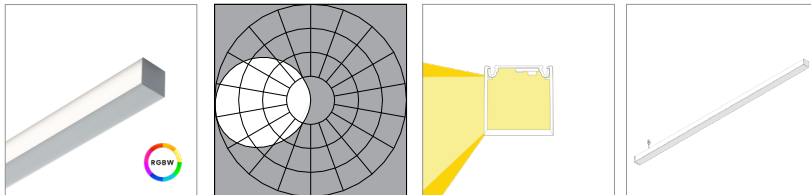

L80 >60,000 hours

	RGBW Color, 90 CRI (90min., 96 avg.)			
	2700K	3000K	3500K	4000K
Low Output (LO)				
Efficacy - Lumens per Watt	56	58	59	60
Lumens per foot (305mm)	471	486	496	501
Watts per foot (305mm)	8.5	8.5	8.5	8.5

	RGBW Color, 90 CRI (90min., 96 avg.)			
	2700K	3000K	3500K	4000K
Standard Output (SO)				
Efficacy - Lumens per Watt	54	55	57	57
Lumens per foot (305mm)	707	729	744	752
Watts per foot (305mm)	13.3	13.3	13.3	13.3

Performance | Zipper Board Optics

Zipper Board Optics design has 72 diodes per foot (305mm).

Square 3535, Critical Edge (S5), black finish (S5-BL)

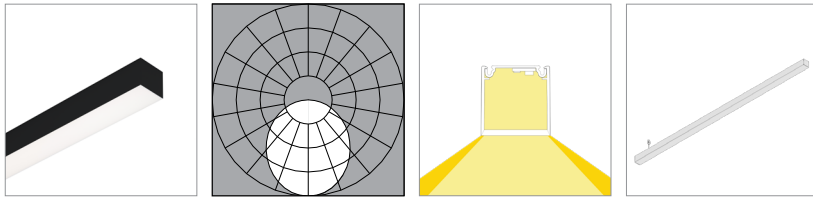

L80 >60,000 hours

90 CRI (90min., 96 avg.)

Low Output (LO)	2700K	3000K	3500K	4000K
Efficacy - Lumens per Watt	65	67	69	69
Lumens per foot (305mm)	241	248	253	256
Watts per foot (305mm)	3.8	3.8	3.8	3.8

Standard Output (SO)	2700K	3000K	3500K	4000K
Efficacy - Lumens per Watt	74	77	78	79
Lumens per foot (305mm)	482	497	507	512
Watts per foot (305mm)	6.6	6.6	6.6	6.6

High Output (HO)	2700K	3000K	3500K	4000K
Efficacy - Lumens per Watt	74	76	77	78
Lumens per foot (305mm)	722	745	760	768
Watts per foot (305mm)	9.9	9.9	9.9	9.9

Square 3535, Side Diffuse (S9), black finish (S9-BL)

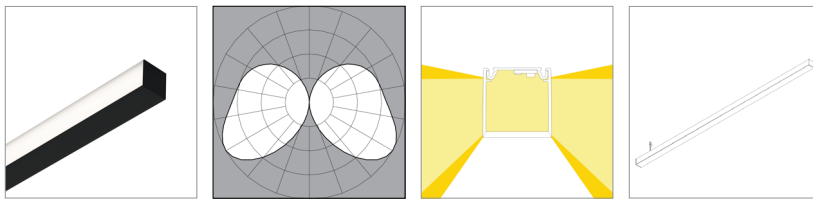

L80 >60,000 hours

90 CRI (90min., 96 avg.)

Low Output (LO)	2700K	3000K	3500K	4000K
Efficacy - Lumens per Watt	81	84	85	86
Lumens per foot (305mm)	300	310	316	319
Watts per foot (305mm)	3.8	3.8	3.8	3.8

Standard Output (SO)	2700K	3000K	3500K	4000K
Efficacy - Lumens per Watt	93	95	97	98
Lumens per foot (305mm)	601	620	632	639
Watts per foot (305mm)	6.6	6.6	6.6	6.6

High Output (HO)	2700K	3000K	3500K	4000K
Efficacy - Lumens per Watt	92	94	96	97
Lumens per foot (305mm)	901	929	948	958
Watts per foot (305mm)	9.9	9.9	9.9	9.9

Performance | Zipper Board Optics | RGBW

Zipper Board Optics design has 72 diodes per foot (305mm).
 RGBW (red, green, blue, and white) tested with **all channels on**.

Square 3535, Critical Edge (S5), black finish (S5-BL)

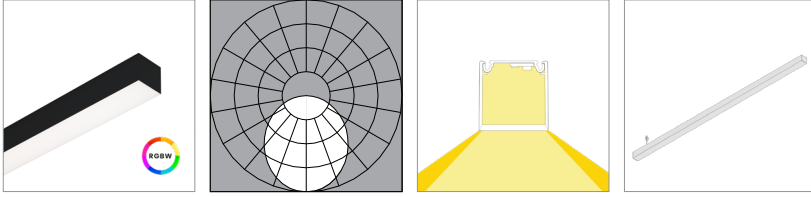

L80 >60,000 hours

RGBW Color, 90 CRI (90min., 96 avg.)

Low Output (LO)	2700K	3000K	3500K	4000K
Efficacy - Lumens per Watt	55	56	58	58
Lumens per foot (305mm)	456	471	480	485
Watts per foot (305mm)	8.5	8.5	8.5	8.5

Standard Output (SO)	2700K	3000K	3500K	4000K
Efficacy - Lumens per Watt	52	54	55	55
Lumens per foot (305mm)	684	706	720	728
Watts per foot (305mm)	13.3	13.3	13.3	13.3

Square 3535, Side Diffuse (S9), black finish (S9-BL)

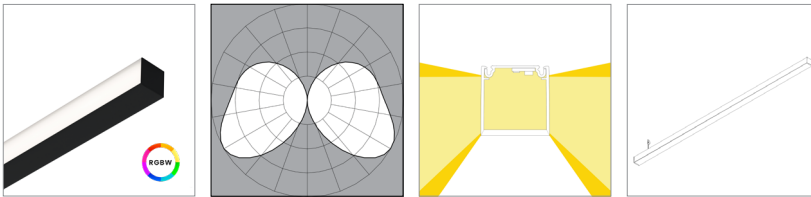

L80 >60,000 hours

RGBW Color, 90 CRI (90min., 96 avg.)

Low Output (LO)	2700K	3000K	3500K	4000K
Efficacy - Lumens per Watt	68	70	72	72
Lumens per foot (305mm)	569	587	599	605
Watts per foot (305mm)	8.5	8.5	8.5	8.5

Standard Output (SO)	2700K	3000K	3500K	4000K
Efficacy - Lumens per Watt	65	67	68	69
Lumens per foot (305mm)	854	881	899	908
Watts per foot (305mm)	13.3	13.3	13.3	13.3

Performance | Zipper Board Optics

Zipper Board Optics design has 72 diodes per foot (305mm).

Square 3535, Single Side Diffuse (SA), black finish (SA-BL)

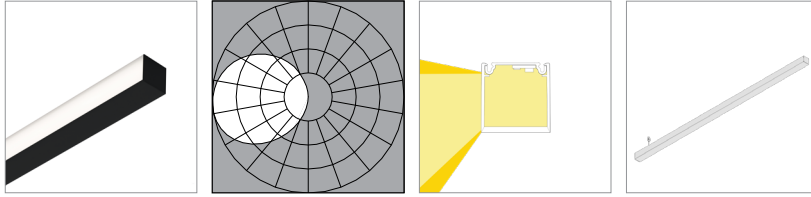

L80 >60,000 hours

90 CRI (90min., 96 avg.)

	2700K	3000K	3500K	4000K
Low Output (LO)				
Efficacy - Lumens per Watt	64	66	67	68
Lumens per foot (305mm)	235	242	247	250
Watts per foot (305mm)	3.8	3.8	3.8	3.8
Standard Output (SO)				
Efficacy - Lumens per Watt	72	75	76	77
Lumens per foot (305mm)	470	485	495	499
Watts per foot (305mm)	6.6	6.6	6.6	6.6
High Output (HO)				
Efficacy - Lumens per Watt	72	74	76	76
Lumens per foot (305mm)	705	727	742	749
Watts per foot (305mm)	9.9	9.9	9.9	9.9

Performance | Zipper Board Optics | RGBW

Zipper Board Optics design has 72 diodes per foot (305mm).
 RGBW (red, green, blue, and white) tested with **all channels on**.

Square 3535, Single Side Diffuse (SA), black finish (SA-BL)

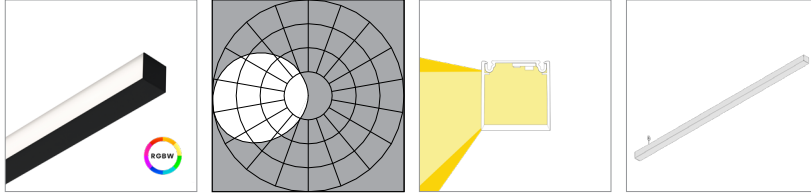

L80 >60,000 hours

RGBW Color, 90 CRI (90min., 96 avg.)

Low Output (LO)	2700K	3000K	3500K	4000K
Efficacy - Lumens per Watt	53	55	56	57
Lumens per foot (305mm)	445	459	469	473
Watts per foot (305mm)	8.5	8.5	8.5	8.5

Standard Output (SO)	2700K	3000K	3500K	4000K
Efficacy - Lumens per Watt	51	52	53	54
Lumens per foot (305mm)	668	689	703	710
Watts per foot (305mm)	13.3	13.3	13.3	13.3

Copyright © 2025 Vode Lighting LLC. All rights reserved. Vode, the Vode logo, BoxRail, FlyWing, MicroBaffle, Button Board, Zipper Board, Zero Canopy, Zero Block, VodeNODE and other names are either registered trademarks or trademarks of Vode Lighting LLC in the United States and may be registered in other countries. All other trademarks listed herein belong to their respective owners. Due to ongoing innovation, specification details may change without notice.